

# JAPANESE MARINE

# ECO PRODUCTS



<b>A</b>	Air Conditioners	USHIO REINETSU CO., LTD.	2
		NISSIN REFRIGERATION & ENGINEERING LTD.	2
	Air Conditioning and Refrigeration Equipment	DAIKIN MR ENGINEERING CO., LTD.	3
	Antifouling Device	Port Enterprise Co., Ltd.	3
	Autopilot	TOKYO KEIKI INC.	4
		YOKOGAWA DENSHIKIKI CO., LTD.	4
<b>B</b>	Ballast Water Inspection Equipment	MOL Techno-Trade, Ltd.	5
		KUNIMORI ENGINEERING WORKS CO., LTD.	5
	Ballast Water Management System	JFE Engineering Corporation	6
		MIURA CO., LTD.	6
	Batteries	BEMAC CORPORATION	7
	Bearings, Sterntubes	MIKASA CORPORATION	7
	Bilge Separator	TAIKO KIKAI INDUSTRIES CO., LTD.	8
		VOLCANO CO., LTD.	9
		VOLCANO CO., LTD.	9
	Boiler Burners	VOLCANO CO., LTD.	10
		VOLCANO CO., LTD.	10
	Bolts, Anti-Corrosion Coating	TAKENAKA SEISAKUSHO CO., LTD.	11
<b>C</b>	Cables & Wires, Electrical	HIEN ELECTRIC INDUSTRIES, LTD.	11
	Clutch	HITACHI NICO TRANSMISSION CO., LTD.	12
	Condensers	YAMASHINA SEIKI CO., LTD.	12
		JRCS Co.Ltd.	13
	Control Systems & Equipment	NISHISHIBA ELECTRIC CO., LTD.	13
		TAIYO ELECTRIC CO., LTD.	14
		TAIYO ELECTRIC CO., LTD.	14
	Coolers, Oil	USHIO REINETSU CO., LTD.	15
<b>D</b>	Diesel engine	HITACHI ZOSEN CORPORATION	15
	Diesel Engines, Auxiliary	DAIHATSU DIESEL MFG. CO., LTD.	16
	Diesel Engine, Propulsion	AKASAKA DIESELS LIMITED	16
	Diesel Engines, Propulsion	THE HANSHIN DIESEL WORKS, LTD.	17
		YANMAR CO., LTD.	17
	DRONE	KUNIMORI ENGINEERING WORKS CO., LTD.	18
	Dual Fuel Engines, Auxiliary	DAIHATSU DIESEL MFG. CO., LTD.	18
	Dual Fuel Engines, Propulsion	NIIGATA POWER SYSTEMS CO., LTD.	19
		YANMAR CO., LTD.	19
	Dual Fuel Engines, propulsion (Low-Speed)	DIESEL UNITED, LTD.	20
<b>E</b>	Eco-Friendly Product	MEIYO ELECTRIC CO., LTD.	21
		MOL Techno-Trade, Ltd.	21
	Engine Telegraphs & Loggers	KEI SYSTEM CO., LTD.	22
	Exhaust Gas Heat Recovery Unit	MIURA CO., LTD.	22
<b>F</b>	Fire Fighting System	Port Enterprise Co., Ltd.	23
		SASAKURA ENGINEERING CO., LTD.	24
	Fresh Water Generating Plant	SASAKURA ENGINEERING CO., LTD.	24
	Fuel Reformer	Port Enterprise Co., Ltd.	25
	FreshWater Producing Unit	KURITA WATER INDUSTRIES LTD.	25
<b>G</b>	Galley Relative Equipment	HSN-KIKAI KOGYO CO., LTD.	26
	Gas Combustion Unit	VOLCANO CO., LTD.	26
	Gas Engine	KAWASAKI HEAVY INDUSTRIES, LTD.	27
<b>H</b>	Hydraulic Control Valve	Nabtesco Corporation	27
<b>L</b>	LNG Pump	SHINKO IND. LTD.	28
<b>M</b>	Monitoring & Control Systems	HSN-KIKAI KOGYO CO., LTD.	28
<b>N</b>	Navigation Lights	NIPPON SENTO CO., LTD.	29
<b>O</b>	Oil Absorbents	Shimada & Co., Ltd.	29
		CHUGOKU MARINE PAINTS, LTD.	30
	Paints	CHUGOKU MARINE PAINTS, LTD.	30
		NIPPON PAINT MARINE COATINGS CO., LTD.	31
		NIPPON PAINT MARINE COATINGS CO., LTD.	31
	Propeller Boss Cap Fins	MOL Techno-Trade, Ltd.	32
	Propellers, Controllable	KAMOME PROPELLER CO., LTD.	33
	Propellers, fixed pitch	KAMOME PROPELLER CO., LTD.	33
		NAKASHIMA PROPELLER CO., LTD.	34
	Pump	NANIWA PUMP MFG. CO., LTD.	35
	Pump, Inverter Control	NANIWA PUMP MFG. CO., LTD.	35
	Pumps, Bilge	HEISHIN Ltd.	36
	Pumps, Deep Well	TAIKO KIKAI INDUSTRIES CO., LTD.	36
<b>R</b>	Reduction Gear	HITACHI NICO TRANSMISSION CO., LTD.	37
	Rudders	JAPAN HAMWORTHY & CO., LTD.	37
	Rudders, High Lift	KAMOME PROPELLER CO., LTD.	38
<b>S</b>	Seals, sterntubes	EAGLE INDUSTRY CO., LTD.	38
		NIIGATA POWER SYSTEMS CO., LTD.	39
	Selective Catalytic Reduction System	YANMAR CO., LTD.	39
	Separators, Oil & Water	HSN-KIKAI KOGYO CO., LTD.	40
	Sewage Treatment Equipment	SASAKURA ENGINEERING CO., LTD.	40
		TAIKO KIKAI INDUSTRIES CO., LTD.	41
	Shaft Driven Generating System	NISHISHIBA ELECTRIC CO., LTD.	41
	Ship and Marine Batteries	ECO MARINE POWER CO., LTD.	42
	Ship and Marine Solar Power	ECO MARINE POWER CO., LTD.	42
	SOx Scrubber	Port Enterprise Co., Ltd.	43
	SOx Scrubber(EDCS) & Laser Gas Analyzer	FUJI ELECTRIC CO., LTD.	43
<b>T</b>	Turbochargers	Turbo Systems United CO., LTD.	44
		Mitsubishi Heavy Industries Marine Machinery & Equipment Co., Ltd.	44
<b>W</b>	Winches, mooring, electric & hydraulic	MANABE ZOKI CO., LTD.	45



## Air Conditioners

 **USHIO USHIO REINETSU CO., LTD.**

<http://www.ushioreinetsu.co.jp/english/>

### Inverter control of FAN and COMPRESSOR



Realize the reduction of CO<sub>2</sub> emissions, will contribute greatly to the global environment.

#### ■ Inverter control of FAN

- Can obtain a greater energy savings by setting the rotation speed of the fan amount corresponding to each operation mode “cooling”, “heating” and “blast”, and improves the comfort of the accommodation space.
- Compared with the damper controlled, there are about 57% reduction of the ratio in the energy equivalent. And there is a reduction of 53.1ton CO<sub>2</sub> / year.

#### ■ Inverter control of COMPRESSOR

- Control by an inverter the rotation speed of the COMPRESSOR. It is effective to keep the operation stable and to reduce power consumption by controlling the finely optimal cooling capacity.

## INQUIRIES

5-3, Creative-Hills, Imabari, Ehime, 794-0069, Japan  
Tel : +81-898-34-1203 Fax : +81-898-34-1204  
E-mail : ushio@ushioreinetsu.co.jp

## Air Conditioners

 **NISSIN REFRIGERATION & ENGINEERING LTD.**

<http://www.nissin-ref.co.jp/english/>

### Heat pump type Ultra compact size Water Chilling Unit



### Ultra compact size Water Chilling and Heat pump Unit

Our heat pump chiller unit has various capabilities by combining each 10 HP (or 5 HP) compressor unit.

Only suitable number of compressor running, also heat pump mode contributes ecological operation.

Every compressor units are independent; hence, even if one unit fails, the operation can be continued with the remaining units.

It's hermetic type compressor benefits maintenance free.

Being lightweight, compact, and reliable, this chiller unit has been widely equipped on government and municipal ships.

## INQUIRIES

1-12-30, Mikuni Hommachi, Yodogawa-ku, Osaka, 532-0005, Japan  
Tel : +81-6-6394-1171 Fax : +81-6-6394-1251  
E-mail : nre-webmaster@nissin-ref.co.jp

# Air Conditioning and Refrigeration Equipment

## DAIKIN MR ENGINEERING CO., LTD.

<http://www.daikin.co.jp/group/dmre/english/>



### New lineup of R407H equipment

Refrigerant R407H has been developed by DAIKIN technology, with over 70 years experience in the field, which provide high efficient and environmentally friendly quality that can be adopted to air conditioners and refrigerators.

### Retrofit to existing systems

We have retrofitted R22 equipment for R404A, and can also retrofit R22, R404A, and R407C equipment to work with R407H. This method can be applied depending on the type of equipment. Please contact us for more information.

- Safety
- High efficiency
- Stability
- Global Availability
- Eco-friendliness

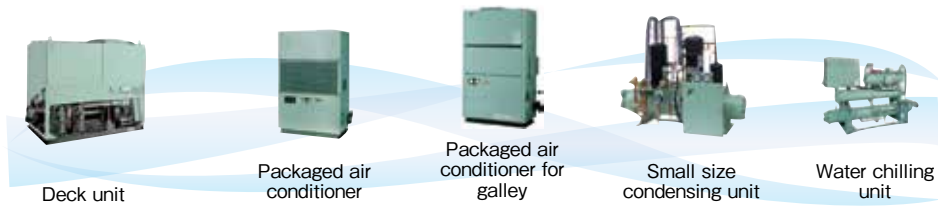

## INQUIRIES

### MARINE EQUIPMENT DIVISION

Shin-osaka Central-tower 11F, 5-5-15 Nishinakajima, Yodogawa-ku, Osaka, 532-0011, Japan  
 Tel : +81-6-4805-7293 Fax : +81-6-4805-7321  
 E-mail : marine.aircon@daikin.co.jp

Reduces Energy Consumption, Maintenance, and Overall Environmental Impact (Chemical Free)

# Antifouling Device

 **Port Enterprise Co., Ltd.**  
*Serving the maritime industry worldwide since 1968*  
*Sailing into the future*

## Port Enterprise Co., Ltd.

<http://www.portenterprise.com>

### Hasytec Dynamic Biofilm Protection

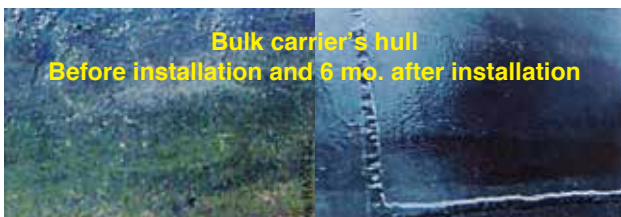

Bulk carrier's hull  
Before installation and 6 mo. after installation

Suezmax tanker's propeller  
Before installation and 6 mo. after installation

Hasytec Dynamic Biofilm Protection protects any surface coming in contact with water from marine fouling with its own chemical-free ultrasound technology at really low cost without any maintenance.

### Widely used to protect heat exchangers



The product is well proven, completely safe, consumes very little energy, needs no maintenance, and comes with 5-year warranty.

## INQUIRIES

No. 2-1-28, Chikko, Minato, Osaka, 552-0021, Japan  
 Tel : +81-6-6573-5391 Fax : +81-6-6575-3036  
 E-mail : penterj@penterj.co.jp

# Autopilot

## TOKYO KEIKI TOKYO KEIKI INC.

<https://www.tokyokeiki.jp/e/>

### PR-9000

The model PR-9000 is the latest autopilot system from TOKYO KEIKI. The PR-9000 is designed using the latest technology from a wealth of engineering and manufacturing experience of navigational instruments. Safety, accuracy, and reliability of information have been enhanced in our model lineup thereby significantly improving situational awareness and navigational safety.

An indispensable autopilot system providing effective and safe bridge resource management and energy efficient navigation.



### Repeater Unit with color LCD

Color LCDs are incorporated into each system which enhances reliability of information and improves situational awareness.

### Maintaining Safe Navigation via Guidance Screen

Steering-related monitoring information can be displayed on the monitor screen. If a warning alert is generated, the navigator can simply view the proper guidance procedures on the screen in order to carry out evasive measures.



(Avoidance operating procedures Guidance Screen)

### Route Control function (ACE)

#### Route Control is performed only with Autopilot

Due to reduced route deviation / shorter sailing distance / reduction of wasted rudder, it ultimately contributes to safety and energy efficient navigation.



(ACE Screen)

## INQUIRIES

### Marine Systems Company

2-16-46, Minami-Kamata, Ohta-ku, Tokyo, 144-8551, Japan

Tel : +81-3-3737-8611 Fax : +81-3-3737-8663

Inquiry [https://www.tokyo-keiki.co.jp/form/webform\\_marinee.html](https://www.tokyo-keiki.co.jp/form/webform_marinee.html)

# Autopilot

## YOKOGAWA DENSHIKIKI CO., LTD.

<http://www.yokogawa.com/ydk>

### Next Generation Autopilot PT900



PT900 is the next generation autopilot, modern controlled fuel saving function (BNAAC/E-Course Pilot) is installed. By introducing 7 inches LCD, navigation information and autopilot parameters are confirmed and changed very easily.

### YOKOGAWA "GREEN" PRODUCTS



## INQUIRIES

### Marine Equipment Business Division

Minami Shinjuku Hoshino Bldg,5-23-13, Sendagaya, Shibuya-ku, Tokyo, 151-0051, Japan

Tel : +81-3-3225-5383 Fax : +81-3-3225-5316

E-mail : [navigation\\_info@ydk.yokogawa.co.jp](mailto:navigation_info@ydk.yokogawa.co.jp)



# Ballast Water Inspection Equipment

**MOL** MOL Techno-Trade, Ltd.

Creating the Future  
**SATAKE**

[http://www.motech.co.jp/e\\_index.html](http://www.motech.co.jp/e_index.html)

## Viable Organism Analyzer "Ballast Eye"



SATAKE CORPORATION, developed machinery for maritime calls "Viable Organism Analyzer" and MOL Techno-Trade, Ltd. handles to sell it in domestic and foreign market. Viable Organism Analyzer can detect the number of viable organisms in the ballast water and it can be used simply and easily on board. The analyzer can estimate the number of both viable organisms of Large size (Minimum diameter  $\geq 50 \mu\text{m}$ ) and Small size (Minimum diameter  $10 \mu\text{m} \leq x < 50 \mu\text{m}$ ) in one unit. It has high correlation for detecting one individual organism at 100ml, and only analyzer which is possible to analyze both zooplankton and phytoplankton in a short time. Analysis can be completed in a simple way by operating touch-screen on the analyzer that means total duration for analysis is approx. 15minutes, including stain time.

## INQUIRIES

MOL Techno-Trade, Ltd. / Ship's Supplies & Machinery Dept.

Tel : +81-3-6367-5370

E-mail : s-voa@motech.co.jp

# Ballast Water Management System

**KEW** KUNIMORI ENGINEERING WORKS CO., LTD.

<http://www.kunimori.co.jp/en/>

## Enhanced Physical Treatment Technology With No Clogging Filtration Unit.

[ Hydro Cyclone Filter ]

- No Maintenance
- No Replacement
- No Clogging

[ High reliability ]

- No one think sieve type filter wouldn't clogged.
- Who can assure a life time of filter under Stringent condition?



## Hydrocyclone Prefilter

- Hydrocyclone technology replaces traditional filters.

## US Prefilter

- System cleaning
- Particle degradation
- Purifying water quality
- Break biological cell walls

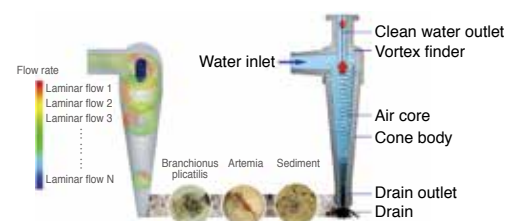

## UV Module

- The real-time UV Dose tracing sterilization technology saves energy for you.



## INQUIRIES

### CHINA PROJECT OFFICE

7-12, 5-Chome, Shinbashi, Minato-ku, Tokyo, 105-0004, Japan

Tel : +81-3-3437-5022 Fax : +81-3-3437-5322

E-mail : liu@kunimori.co.jp

# Ballast Water Management System

 **JFE Engineering Corporation**

<https://jfe-ballast-ace.com/>

## JFE BallastAce



## Filtration + Formulated Chemical Injection

JFE BallastAce is a BWMS using a combination of filtration followed by formulated chemical injection on ballast water intake, and controlled neutralization step before ballast discharge.

The system has already delivered to more than 500 vessels, including over 100 retrofits.

### ■ Feature of JFE BallastAce

- Efficient sterilization in a wide range of water quality (turbidity / salinity / water temperature)
- Extremely low power consumption, low impact on the generators
- Flexible layout by each component in limited space

## INQUIRIES

### Ballast Water Management System Division

2-1, Suehiro-cho, Tsurumi-ku, Yokohama, 230-8611, Japan

Tel : +81-45-505-6538

E-mail : [jfe-bwms@jfe-eng.co.jp](mailto:jfe-bwms@jfe-eng.co.jp)

# Ballast Water Management System

 **MIURA CO., LTD.**

<http://www.miuraz.co.jp/en/bwts/>



### 【Introduction】

MIURA work towards our mission of "Helping customers all over the world in energy conservation and environmental preservation."

With fifty years of proven result of ship machinery department, utilizing our technology and trust in MIURA, we put all effort to achieve our goal.

### 【Miura BWMS HK-type】

We introduce "Miura Ballast water management system" that contribute to marine environment conservation all over the world.

Miura BWMS HK-type adopts filter and UV irradiation method which is environmentally friendly that does not affect natural ecosystem of sea area where water is discharged.

With its uniquely developed filter, system can surely capture organisms larger than 50 $\mu$ m, and multi-stage cleaning function can maintain filter clean.

In addition, operation of UV reactor is controlled to be energy saving. Control panel is operated using touch panel, which has high visibility and operability.

### 【Retrofit】

MIURA supervisors support retrofit engineering work from 3D scanning to installation work, and promote the installation work in accordance with the plan.

## INQUIRIES

7 Horie-cho, Matsuyama, Ehime, 799-2696, Japan

Tel : +81-89-979-7060 Fax : +81-89-979-7082

E-mail : [hakuyo\\_eka@miuraz.co.jp](mailto:hakuyo_eka@miuraz.co.jp)

# Batteries

## BEMAC BEMAC CORPORATION

<http://www.bemac-jp.com>

### Optimizing Electric Power System by Applying Lithium-ion Batteries



Fig.1 Applications of Li-ion Batteries on Ships



Fig.2 Li-ion Battery system

BEMAC has been introducing application of Lithium-ion batteries on ship's electrical system for electrical power efficient usage.

Ship's electrical energy volumes are consumed according to running mode which also the usages of Lithium-ion batteries' applications depends on (Fig.1). For example, its application to bow thruster during entering / existing the port may be used, and during the voyage, it may be applicable for charging the batteries by surplus electric power. Depending on its running mode, system will control charging and discharging of the Lithium-ion batteries by time shifting the ship's electrical power consumption; thus, to cut down the cost of generators' fuel.

BEMAC could supply Lithium-ion Battery Charging and Discharging equipments, Monitoring system and all necessary equipments (Fig.2).

### INQUIRIES

#### Head Office / MIRAI Factory

105 Noma, Imabari-city, Ehime Pref., 794-8582, Japan

Tel : +81-898-25-8282 Fax : +81-898-25-3777

E-mail : [sales@bemac-jp.com](mailto:sales@bemac-jp.com)

# Bearings, Sterntubes



## MIKASA CORPORATION

<http://www.mikasa-industry.com/en/>

### Water Lubricated Bearing F.F.Bearing (Friction-Free-Bearing)

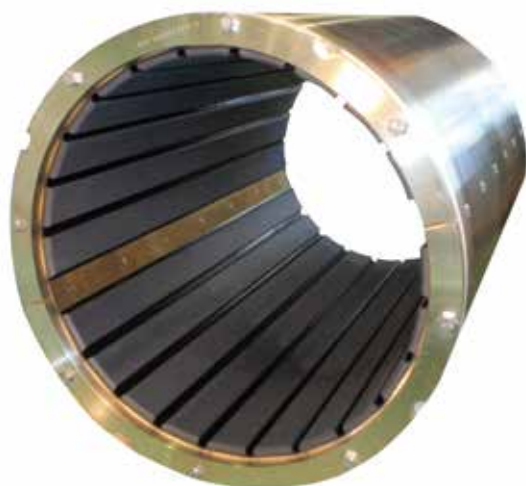

As a result of pursuing superior low friction property and heavy duty property, we developed combined bearings made of P.T.F.E. and synthetic rubber and metal shell for Water-lubricated stern tube bearing.

F.F. Bearing dramatically minimizes both shaft sleeve and bearing wear.

This is the result of using PTFE of high self-lubricating as the slide member, distributing rubber to the back as the cushion to obtain the self-alignmentability, and decreasing the load by the deflected contact.

It is available water lubricating system as an alternative system of oil lubricating system..

By changing into F.F. Bearing were resulting in:

- Reduced Fuel Consumption
- Lower Vibration
- Lower Noise Levels
- Less Maintenance Cost
- No Possibility of Sea Contamination

### INQUIRIES

Mr. Noriaki Hirata

General Manager International Sales Dept., Industrial Products Div.

MIKASA CORPORATION

1, Kuchi, Asa-cho, Asakita-ku, Hiroshima, 731-3362, Japan

Tel : +81-82-810-3930 Fax : +81-82-837-3947

E-mail : [hirata@mikasasports.co.jp](mailto:hirata@mikasasports.co.jp)



# Bilge Separator

**TAIKO** TAIKO KIKAI INDUSTRIES CO., LTD.

[www.https://www.taiko-kk.com/en](https://www.taiko-kk.com/en)

## Bilge Separator



TAIKO's USH series of marine bilge separators was developed by combining the technology of our three previous bilge separators when MEPC.107 (49) took effect. The USH series of new and powerful bilge separators is equipped with a high-performance, long-life coalescer capable of dealing not only with high-density and viscosity oil, but also emulsions that previous coalescers could not deal with.

## INQUIRIES

209-1 Shimotabuse, Tabuse-cho, Kumage-gun, Yamaguchi, 742-1598, Japan

Tel : +81-820-52-3113 Fax : +81-820-53-1001

E-mail : Please contact our website

# Boiler Burners

**Volcano** VOLCANO CO., LTD.

<http://www.volcano.co.jp/english/index.html>

## Proportional control type oil burner "MJ II-M"



Design and development of "MJ II-M" fully automated pressure jet proportional control burner allows energy saving operation with composite boiler. Features are as followings.

- Proportional control (turn down ratio / 3:1) allows for reducing the burner ON / OFF switching and improving the boiler efficiency.
- Combustion of both HFO and MGO fuels without changing atomizers.
- Easy and quick replaceable coupler attached on fuel line allows for less maintenance time.
- "MJII-M" is applied for 1~3t/h boiler.

## INQUIRIES

**Sales Department, Combustion Engineering Division**  
1-3-38 Nonaka-kita, Yodogawa-ku, Osaka, 532-0034, Japan  
Tel : +81-6-6392-5541 Fax : +81-6-6396-7609  
E-mail : info-m@volcano.co.jp

# Boiler Burners

**Volcano** VOLCANO CO., LTD.

<http://www.volcano.co.jp/english/index.html>

## GAS / OIL Simultaneous Combustion DF burner

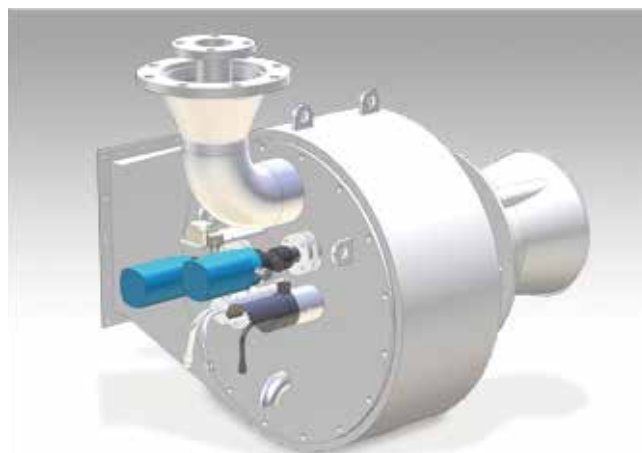

This DF burner "Vignis" is suitable for LNG Fueled vessels which are expected to increase. Features are as followings.

- "Vignis", featuring the turndown ratio of 10:1 allows for energy-saving operation.
- Equipped with the Gas/Oil Simultaneous Mixed Combustion mode as well as the Gas/Oil Mono-fuel combustion modes, "Vignis" will allow for energy-saving operation.
- With the Gas/Oil Simultaneous Mixed Combustion mode, the Gas/Oil ratio can be freely set to allow for economical operation in accordance with each vessel's circumstances.
- "Vignis" is applied for 4~10t/h boiler.

On LNG Fueled vessels, BOG would be generated. CH<sub>4</sub>, which is main component of BOG, is 25 times more potent than CO<sub>2</sub> for global warming. Gas/Oil Simultaneous Mixed Combustion makes it possible to process CH<sub>4</sub> without emitting into the atmosphere.

## INQUIRIES

**Sales Department, Combustion Engineering Division**  
1-3-38 Nonaka-kita, Yodogawa-ku, Osaka, 532-0034, Japan  
Tel : +81-6-6392-5541 Fax : +81-6-6396-7609  
E-mail : info-m@volcano.co.jp

### VOLCANO has 90years History.

We have more than 38years experiences of LNG Fuel for marine use.

We have delivery records for more than 190 vessels and have a reputation as safe and secure.

# Boiler Burners

**Volcano** VOLCANO CO., LTD.

<http://www.volcano.co.jp/english/index.html>

## GAS / OIL Simultaneous Combustion DF burner



### VOLCANO has 90years History.

We have more than 38years experiences of LNG Fuel for marine use.

We have delivery records for more than 190 vessels and have a reputation as safe and secure.

This DF burner "Vignis-mini" is suitable for LNG Fueled vessels which are expected to increase. Features are as followings.

- "Vignis-mini", featuring the turndown ratio of 10:1 allows for energy-saving operation.
- Equipped with the Gas/Oil Simultaneous Mixed Combustion mode as well as the Gas/Oil Mono-fuel combustion modes, "Vignis-mini" will allow for energy-saving operation.
- With the Gas/Oil Simultaneous Mixed Combustion mode, the Gas/Oil ratio can be freely set to allow for economical operation in accordance with each vessel's circumstances.
- "Vignis-mini" is applied for 1~3t/h boiler.

On LNG Fueled vessels, BOG would be generated. CH<sub>4</sub>, which is main component of BOG, is 25 times more potent than CO<sub>2</sub> for global warming. Gas/Oil Simultaneous Mixed Combustion makes it possible to process CH<sub>4</sub> without emitting into the atmosphere.

## INQUIRIES

### Sales Department, Combustion Engineering Division

1-3-38 Nonaka-kita, Yodogawa-ku, Osaka, 532-0034, Japan

Tel : +81-6-6392-5541 Fax : +81-6-6396-7609

E-mail : info-m@volcano.co.jp

# Boiler Burners

**Volcano** VOLCANO CO., LTD.

<http://www.volcano.co.jp/english/index.html>

## GAS / OIL Simultaneous Combustion DF burner "SFFG II



### VOLCANO has 90years History.

We have more than 38years experiences of LNG Fuel for marine use.

We have delivery records for more than 190 vessels and have a reputation as safe and secure.

This DF burner "SFFG II" was designed and developed for the main boiler on LNG carriers and is currently being used by many LNG carriers, FPSO, FSRU. "SFFG II" is also suitable for LNG Fueled Vessels.

Features are as followings.

- "SFFG II", featuring the turndown ratio of 15:1(Oil) and 7:1(Gas) allows for energy-saving operation.
- Equipped with the Gas/Oil Simultaneous Mixed Combustion mode as well as the Gas/Oil Mono-fuel combustion modes, "SFFG II" will allow for energy-saving operation.
- With the Gas/Oil Simultaneous Mixed Combustion mode, the Gas/Oil ratio can be freely set to allow for economical operation in accordance with each vessel's circumstances.
- "SFFG II" is applied for 6~70t/h boiler.

On LNG Fueled vessels, BOG would be generated. CH<sub>4</sub>, which is main component of BOG, is 25 times more potent than CO<sub>2</sub> for global warming. Gas/Oil Simultaneous Mixed Combustion makes it possible to process CH<sub>4</sub> without emitting into the atmosphere.

## INQUIRIES

### Sales Department, Combustion Engineering Division

1-3-38 Nonaka-kita, Yodogawa-ku, Osaka, 532-0034, Japan

Tel : +81-6-6392-5541 Fax : +81-6-6396-7609

E-mail : info-m@volcano.co.jp



# Bolts, Anti-Corrosion Coating

## TAKENAKA SEISAKUSHO CO., LTD.

<https://www.takenaka-mfg.co.jp/en/>

### TAKECOAT-1000 & TAKECOAT-CERAMIC1



TAKECOAT-1000

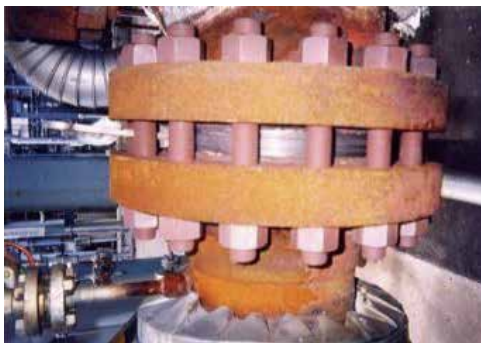

TAKECOAT-CERAMIC1

TAKENAKA has 83 years history experience of leading manufacture for Nuts and Bolt.

【Feature】

- TAKECOAT-1000: ① Resistance to rust and corrosion.  
② Remarkable saving life cycle cost for marine safety.
- TAKECOAT-CERAMIC1: ① Excellent heat resistance up to 450°C  
② Long-term durability for severe environment

### TAKENAKA's original two layer coating system



TAKECOAT-1000

TAKECOAT-CERAMIC1

## INQUIRIES

TAKENAKA SEISAKUSHO CO., LTD. Tokyo Sales Dept.

Tel : +81-3-5643-0780 Fax : +81-3-5643-0781

E-mail : fasteners@takenaka-mfg.co.jp

### Halogen - free

# Cables & Wires, Electrical



## HIEN ELECTRIC INDUSTRIES, LTD.

[http://www.hien.co.jp/e/e\\_index](http://www.hien.co.jp/e/e_index)

### Halogen-free Flame-retardant cables



**ClassNK** In compliance with the ISO9001 quality management system and the ISO14001 environmental management system

**ISO 9001**  
**ISO 14001**

### high degree of toughness

- (1) Protection against external impact
- (2) Steel wire braid against sparks during welding
- (3) Plastic coating protected against steel wire corrosion

### for Control & Instrumental Multicore cable

150/250V FA-MPOC-7x1.0

(Multi core, EP rubber insulated, Polyolefin sheathed and steel wire braided cable)

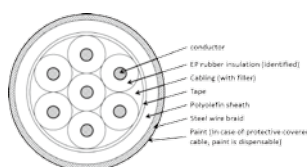

Our products are made in Kyoto, JAPAN

### for Power & Lighting cable

0.6/1kV FA-TPOCO-70

(Three core, EP rubber insulated, Polyolefin sheathed and steel wire braided cable with Polyolefin protective covering)

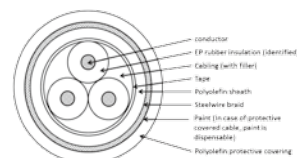

### You can add characteristic and service to the cable

- We have many custom variation, such as Cold proof, Oil resistant, Corrugated tube, and so on.
- We save your waste of cables by the HIEN cut shipping service.



Shipping view

## INQUIRIES

505, Shinshibakawa Bldg., 3-4-11, Dosho-machi, Chuo-ku, Osaka, 541-0045, Japan

Tel : +81-6-6226-1501 Fax : +81-6-6226-1507

E-mail : hien-sales@hien.co.jp

# Clutch



## HITACHI NICO TRANSMISSION CO., LTD.

<http://www.hitachi-nico.jp/en/index.html>

### Large Size Hydraulic Clutch



Large Size Hydraulic Clutch Prototype model



3D model

#### 【Outline】

Large size hydraulic clutch has been developed as the technological development aid project in 2011, 2012 by The Nippon Foundation.

- Selectable for 2kinds of clutch plate of  $\phi 1100\text{mm}$  and  $\phi 1500\text{mm}$ .
- 6 times of transmitting capacity compared with experienced clutch plate,  $\phi 810\text{mm}$  max.

#### 【Feature】

- Appropriate for 20000kw class of large vessel such as Capesize, Handymax.
- Remote control connected with electric valve enable easy operation for Clutch On-Off.
- Can be used for various layout like Two engine-one shaft vessel, Two engine-two shaft vessel, Hybrid propulsion vessel.

### INQUIRIES

405-3 Yoshinocho 1-chome, Kita-ku, Saitama, 331-0811, Japan  
 Tel : +81-48-652-6708 Fax : +81-48-652-8719  
<https://www8.hitachi.co.jp/inquiry/hitachi-nico/en/form.jsp>

# Condensers

## yasec YAMASHINA SEIKI CO., LTD.

<http://yasec.co.jp/english/>

### e-DRAIN

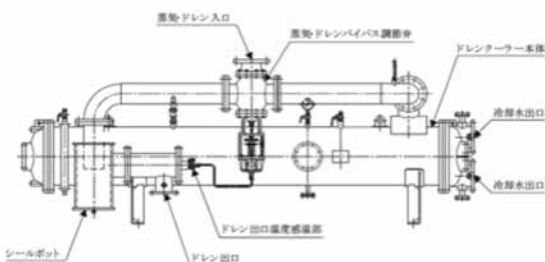

The boiler efficiency is improved by controlling temperatures of drain at the drain cooler exit at a constant level, instead of wasting heat of steam and drain into seawater.

### INQUIRIES

525, Higashizaka, Ritto-City, Shiga, 520-3031, Japan  
 Tel : +81-77-558-2311 Fax : +81-77-558-2319  
 E-mail : [info@yasec.co.jp](mailto:info@yasec.co.jp)

# Control Systems & Equipment



<https://www.jrcs.co.jp/en/>

## J-S/Eco (JRCS Smart Eco system)

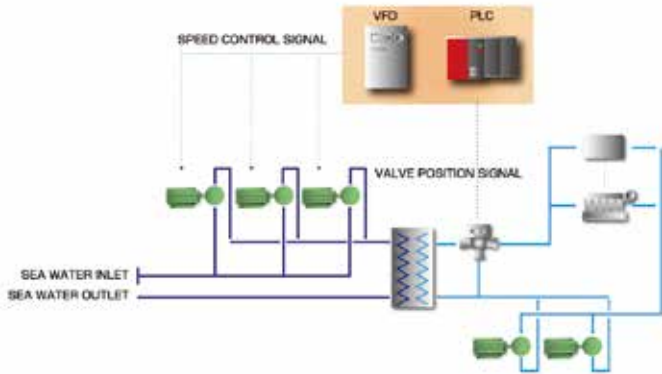

J-S/Eco applies a smart frequency drive system which controls the speed of the motor of the main cooling sea water pumps at the most efficient point. It enables to reduce the power consumed by the motors to the minimum level, resulting in reduction of the vessel's fuel consumption. The equipment is specially designed for marine application for its harsh environment with long term guarantee by JRCS making sure that the ship owners recoup the initial investment back as fast as possible.

## INQUIRIES

2155 Kawatana, Toyoura-cho, Shimonoseki, Yamaguchi, 759-6301 Japan  
Tel : +81-83-775-2030  
E-mail : [jrcs@jrcs.co.jp](mailto:jrcs@jrcs.co.jp)

# Control Systems & Equipment



<http://www.nishishiba.co.jp/nsdk/index.htm>

## C.S.W. Pump Motor Inverter Driven System



As the C.S.W. pump usually operates at rated constant speed, it consumes unnecessary electric power by overcooling.

Therefore we propose cost-effective system which could be controlled by inverter and PLC.

It can also apply this system to the ship in service (retro-fit)

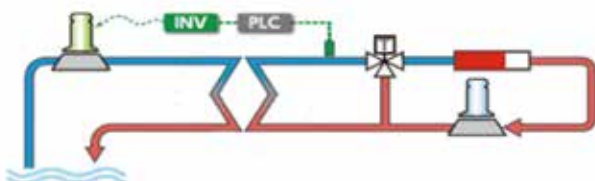

## INQUIRIES

**Osaka Branch**  
29th Fl., Umeda Sky Building West Tower, 1-30 Oyodonaka 1-chome,  
Kita-ku, Osaka, 531-6129, Japan  
Tel : +81-6-4797-2451 Fax : +81-6-4797-2453



# Control Systems & Equipment



**TAIYO ELECTRIC CO., LTD.**

<http://www.taiyo-electric.co.jp/english/index.html>

## Power Supply System

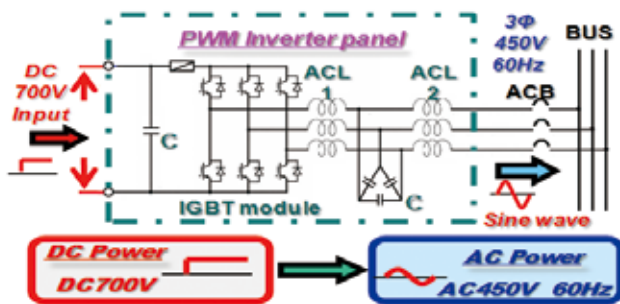

1. Thyristor Inverter Type Shaft Generating System  
SG mode (Generator) /SM mode (M/E boosting) /PM mode (Electric propulsion)
2. PWM Shaft Gen System
3. TC Generating System by PWM Inverter
4. DC Power System by PWM Inverter

This system supplies the stable AC power to the vessel which obtained from the various source.

This system contributes to users energy saving and maintenance cost saving.

Also, the output of this system has same electric characteristic as that of Diesel Generators (DG).

Therefore, it can be operated not only single running but also parallel running with DG.

## INQUIRIES

**Marine Business Division, Overseas Business Dept.**  
1-16-8 Uchikanda, Chiyoda-ku, Tokyo, 101-0047, Japan  
Tel : +81-3-3293-3067 Fax : +81-3-3292-7012  
E-mail : e-mail@taiyo-electric.co.jp

# Control Systems & Equipment



**TAIYO ELECTRIC CO., LTD.**

<http://www.taiyo-electric.co.jp/english/index.html>

## Speed Control System by Inverter



1. Electric Propulsion System
2. Cargo Oil Pump
3. Electric Deck Machinery
4. Air Lub. Blower
5. Cool SW Pump
6. Refrigerator Compressor
7. E/R Ventilation Fan

The speed of Induction motor shall be variably controlled by inverter. Energy saving can be achieved by saving consumed power which is done by controlling motor speed properly.

This system also contributes ship's operation by easy maintenance.

## INQUIRIES

**Marine Business Division, Overseas Business Dept.**  
1-16-8 Uchikanda, Chiyoda-ku, Tokyo, 101-0047, Japan  
Tel : +81-3-3293-3067 Fax : +81-3-3292-7012  
E-mail : e-mail@taiyo-electric.co.jp

## Coolers, Oil

 **USHIO USHIO REINETSU CO., LTD.**

<http://www.ushioreinetsu.co.jp/english/>

### MGO cooling system



The low viscosity of the sulphur fuels may cause engine troubles. This MGO Cooling System is the best solution to achieve both “low sulphur” and “low viscosity”.

- SOx emission control from ships
- EU Directive / Less than 0.1% sulphur content from 1st January, 2010
- CARB(California Air Resource Board) /Less than0.1% sulphur content from 1st January, 2012
- SECA(Sulfur Emission Control Area)/Less than0.1% sulphur content from 1st January, 2015

### INQUIRIES

5-3, Creative-Hills, Imabari, Ehime, 794-0069, Japan

Tel : +81-898-34-1203 Fax : +81-898-34-1204

E-mail : ushio@ushioreinetsu.co.jp

## Diesel engine

 **HITACHI ZOSEN CORPORATION**

<http://www.hitachizosen.co.jp/english/index.html>

### SCR System for 2 stroke engines



Hitachi Zosen has started producing “Hit Green SCR” compiled with NOx Tier III Regulation in Japan, China and Korea. Shop and sea trial has completed.

The running hour of first Hit Green SCR is over 11,000 hours. Hitachi Zosen received official production approval from MAN-ES, and full approval is given only to Hitachi Zosen.

Hitachi Zosen has developed 2nd generation HP-SCR in order to minimize weight and maximize cargo space.

### INQUIRIES

**Sales Department Marine Machinery & SCR System Business Unit  
Machinery Business Headquarters**

Tel : +81-3-6404-0143 Fax : +81-3-6404-0149

E-mail : scr-maritime@hitachizosen.co.jp

# Diesel Engines, Auxiliary

## DAIHATSU DAIHATSU DIESEL MFG. CO., LTD.

<http://www.dhtd.co.jp/en/index.html>

8DEL-23



A long-stroke version of the eco-friendly DE-23 debuts, saving space with greater power and low fuel consumption.

With the installation of environmental devices and the increase in electronic equipment, onboard power consumption has been rising in recent years.

In response to this trend, we have incorporated a long-stroke design in our DE-23 diesel engine for marine use, an engine which has already received wide acclaim since the first deliveries in 2011.

The superb environmental performance remains the same, while achieving space-saving and greatly increased output.

### INQUIRIES

2-10, Nihonbashi-Honcho 2-chome, Chuo-ku, Tokyo, 103-0023, Japan

Tel : +81-3-3279-0821 Fax : +81-3-3245-0395

E-mail : shinsuke.okajima@dhtd.co.jp

# Diesel Engine, Propulsion



## AKASAKA DIESELS LIMITED

<http://www.akasaka-diesel.jp/en/>

The Lowest Fuel Consumption UE Diesel Engine, UEC33LSE-C2 and UEC35LSE-Eco-B2



Akasaka Diesels Limited is one of the leading manufactures of main engine for ship propulsion in Japan. Akasaka has been producing own design low speed 4 stroke engine and 2 stroke UE engine designed by Japan Engine Corporation. (Hereinafter called "J-ENG") The basic design for UEC35LSE-Eco-B2 (electronically controlled engine) was jointly developed by Winterthur Gas & Diesel and J-ENG. The electronically controlled potion for UEC35LSE-Eco-B2 was originally developed by J-ENG and UEC35LSE-Eco-B2 obtains the lowest fuel oil consumption in this class of the engines. UEC33LSE-C2 is mechanical type engine using the base design of UEC35LSE. Both type of engine have been adopted for many kind of small vessel, Bulk career, Chemical tanker, Asphalt tanker, LPG, Container, Cement carrier, Ferry and Ro-Ro.

### INQUIRIES

Tokyo head office, Oversea Sales Dept.

14th floor, south tower Yurakucho Denki Building, 1-7-1 Yurakucho, Chiyoda-Ku ,Tokyo Japan.

Tel : +81-3-6860-9085

E-mail : kaigaieigyuu@akasaka.co.jp

Model	Rated Power (kW)	Specific Fuel Oil Consumption (g/kWh) (ISO)	Eng. speed (rpm)	Engine Output (kW)			
				A	B	C	D
UEC35LSE Eco-B2	P1	187.0	167	4,200	5,220	6,090	6,960
	P2	180.0		3,320	3,960	4,600	5,240
	P3	187.0	118	3,075	3,690	4,305	4,920
	P4	180.0		2,350	2,820	3,290	3,760
UEC33LSE C2	P1	174.0	167	4,150	4,965	5,810	6,640
	P2	170.0		3,320	3,960	4,600	5,240
	P3	173.8	121	3,000	3,600	4,200	4,800
	P4	166.6		2,400	2,880	3,360	3,840



# Diesel Engines, Propulsion



## THE HANSHIN DIESEL WORKS, LTD.

<http://www.hanshin-dw.co.jp/english/product.html>

### Electronically controlled low speed four-stroke diesel engines



We The HANSHIN DIESEL WORKS, LTD. are the general maker of main engines and propulsion systems for ships, and have produced products by our own technology since 1918.

In order to meet the recent environmental requirements, the electronic management of engines is one of the most effective solutions. Electronically controlled two-stroke diesel engines have already been launched in the market. However such kind of Low-Speed four-stroke diesel engine has not been introduced yet.

The HANSHIN DIESEL WORKS, LTD. has newly developed electronically controlled low speed four-stroke diesel engines. One of the most typical features of this type of engine is to save fuel oil consumption by controlling electronically the fuel injection pattern in partial load. This system reduces fuel oil consumption by 3 to 5% in comparison with the conventional mechanically controlled system. This new system is adopted in the engine series of LH46LE, LH41LE, and LA32E.

### INQUIRIES

#### Overseas Business Section

Tel : +81-78-335-6001

Email : overseas-section@hanshin-dw.co.jp

# Diesel Engines, Propulsion

## YANMAR YANMAR CO., LTD.

<https://www.yanmar.com/global/marinecommercial/>

### 2-Stage Turbocharging System



Yanmar has always pursued low fuel consumptions as its corporate creed "Fuel reward to Nation" since foundation.

This time, we developed "2-stage turbocharging system" compliant with IMO Tier2 regulations, further evolving the engine, achieving far superior to the conventional engine.

#### Top view

blue arrow → exhaust  
red arrow → Exhaust

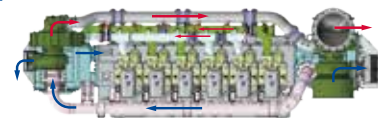

#### Simple system

It has simple system that 2 turbochargers and 2 air coolers are only connected by suction air pipes and exhaust pipe. It enables easy maintainance of the system.

#### Unchanged mountability and Good acceleration

We arranged turbocharger & air cooler unit on both sides of the engine. By this structure, we could achieve the equivalent mountability as the base engine by keeping the height of engine. This engine has good acceleration at low load by adapting dynamic pressure type exhaust manifold.

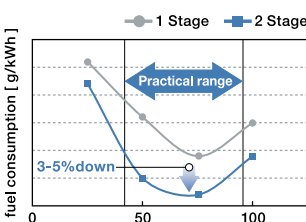

### Evolution of high pressure Miller Cycle System

We acquired the air by using "2-stage turbocharging system" in spite of advanced closing timing of suction valve to compare with "1 stage turbocharging system". It enabled to achieve the low fuel consumption in wide load.

### INQUIRIES

#### No.1 Sales Group Overseas Sales Division Marine Products Sales and Marketing Division Power Solution Business

1-1-1, Nagasu Higashidori, Amagasaki, Hyogo, 660-8585, Japan

Tel : +81-6-6489-8042 Fax : +81-6-6489-1082

E-mail : ichiro\_fuwa@yanmar.com

# DRONE

## **KEW** KUNIMORI ENGINEERING WORKS CO., LTD.

<http://www.kunimori.co.jp/en/>

### DRONE 「ELIOS」

Inspect & explore inaccessible places (Cargo Hold, Tank etc.) safely, quickly and economically using the spherical drone Flyability ELIOS.



- No-Compass Error because no-GPS Signal is required
- Fly safely thanks to the collision tolerant carbon-fiber guard
- High intensity LED lights (2000 lumens)
- High-definition visible-light camera and thermal sensor

Elios is available for purchase or rental in addition to our inspection services.



### INQUIRIES

2-15, 2-Chome, Meiwadori, Hyogo-ku, Kobe, 652-0883, Japan  
Tel : +81-78-686-0320 Fax : +81-78-686-0332  
E-mail : t.isihara@kunimori.co.jp

# Dual Fuel Engines, Auxiliary

## **DAIHATSU** DAIHATSU DIESEL MFG. CO., LTD.

<http://www.dhtd.co.jp/en/index.html>

### Dual fuel engines DE20DF / DE28DF / DE35DF



DE20DF is 205mm bore x 300mm stroke, DE28DF is 280mm bore x 390mm stroke and DE35DF is 350mm bore x 440mm stroke. They cover the output range of 0.9-4.0MWe.

The common rail pilot injection system is applied for stable combustion, and can be use MGO, MDO, HFO and LNG as main fuel. Based on the optimization of A/F-ratio and other many parameters on gas mode operation, these engines are applicable to IMO NOx Tier III regulation without any exhaust gas after-treatment, can also reduce CO<sub>2</sub> of 23%, SOx/PM of over 99%.

The safety concept is in accordance with IGF code. If a gas mode trip happens, the engine switches over from gas mode to diesel mode operation immediately without any fluctuation of the engine output and revolution.

### INQUIRIES

2-10, Nihonbashi-Honcho 2-chome, Chuo-ku, Tokyo, 103-0023, Japan  
Tel : +81-3-3279-0821 Fax : +81-3-3245-0395  
E-mail : shinsuke.okajima@dhtd.co.jp

## Dual Fuel Engines, Propulsion

**NIIGATA** NIIGATA POWER SYSTEMS CO., LTD.

<http://www.niigata-power.com/english/index.html>

28AHX-DF

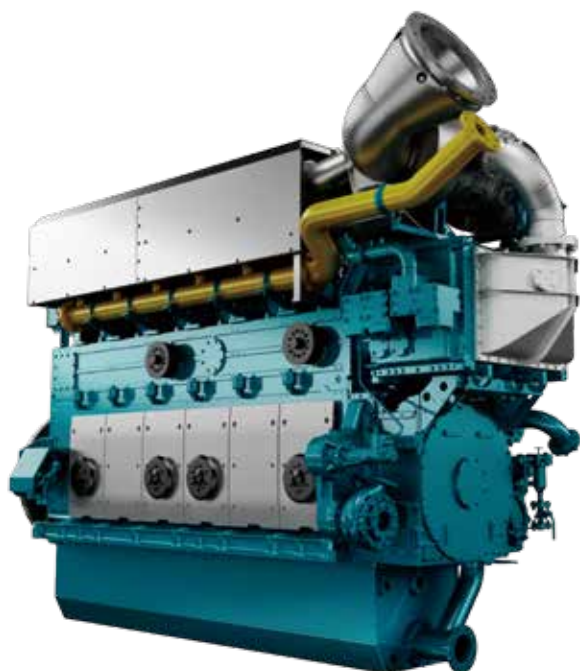

- There are some vessels in operation equipping with Niigata 28AHX-DF in Japan and in Singapore. Now other vessels are under construction with Niigata 28AHX-DF in all over the world.
- The 28AHX-DF is an environmentally friendly engine, satisfying IMO Tier III NOx regulations. It uses clean gas combustion, making it possible to meet the new regulations without the need for an exhaust gas processing reactor.
- The 28AHX-DF offers both gas and diesel operation modes. It can be instantly switched at full load from gas to diesel operation, ensuring safe ship operation even in emergency situations.
- The 28AHX-DF is the world's first FPP directly couplable gas engine. It offers high dynamic performance equivalent to that of a diesel engine even during gas operation, as well as load pickup times, from idling to rated output, which compare favorably with diesel gas engines.
- IHI Power Systems Co., Ltd. (planned) is its new trade name from July, 2019.

### INQUIRIES

14-5, Sotokanda 2-Chome, Chiyoda-ku, Tokyo, 101-0021, Japan  
Tel : +81-3-4366-1226 Fax : +81-3-4366-1310  
E-mail : info1\_sales1@niigata-power.com

### Environmental Technologies

## Dual Fuel Engines, Propulsion

**YANMAR** YANMAR CO., LTD.

<https://www.yanmar.com/global/marinecommercial/>

6EY26DF

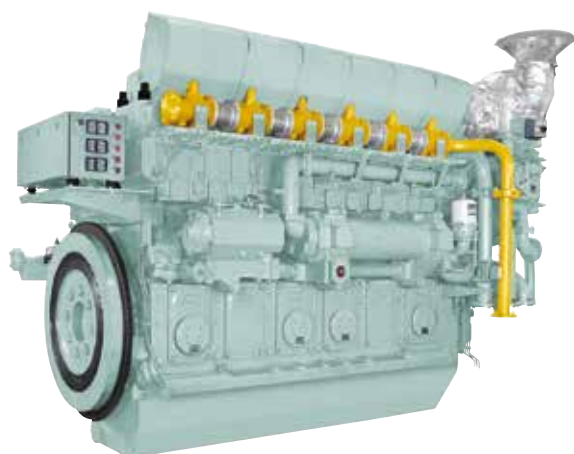

The major feature of this engine is the redundancy capability due to the use of dual fuels. This engine is possible to continue operation by changing over to the diesel mode automatically, even when the gas mode operation fail.

In addition, the micro-pilot with its intense energy, ensures stable ignition capability. And the air-flow quantity control system with the bypass and waste-gate improves the engine transient response. These technologies enables adapt the engine as a ship propulsion engine.

Dual fuel engine has the following characteristics.

- Adaption IMO Tier 3 regulation.
- Redundancy by Dual Fuel (LNG and MDO / HFO).
- Stable ignition ability by Micro Pilot.

### INQUIRIES

**No.1 Sales Group Overseas Sales Division**  
**Marine Products Sales and Marketing Division**  
**Power Solution Business**

1-1-1, Nagasu Higashidori, Amagasaki, Hyogo, 660-8585, Japan  
Tel : +81-6-6489-8042 Fax : +81-6-6489-1082  
E-mail : ichiro\_fuwa@yanmar.com



# Dual Fuel Engines, propulsion (Low-Speed)

**DU** DIESEL UNITED, LTD.

**IHI** GROUP  
Realize your dreams

<http://www.ihico.jp/du/english/home/home.html>



6X72DF

## Low-speed Low-pressure Dual fuel engine "X-DF"

- ◆X-DF applies the pre-mixed lean burn technology and can meet IMO Tier III requirement without the exhaust gas after-treatment.
- ◆X-DF has advantages of lower Capex and Opex due to no requirement of a high pressure compressor.
- ◆For safety concerns, X-DF uses low-pressure LNG. (< 13bar)
- ◆X-DF can switch from gas mode to diesel mode immediately.
- ◆X-DF is based on the low-speed two-stroke engine which is much proven in marine use.

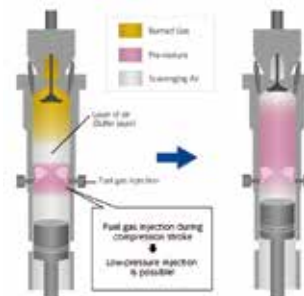

DU-WinGD X-DF engine is the best eco-friendly solution!

## INQUIRIES

Prime Kanda Bldg., 2-8, Kanda Suda-cho, Chiyoda-ku, Tokyo 101-0041, Japan

Tel : +81-3-3257-8222 Fax : +81-3-3257-8220

E-mail : [info@du.ihico.jp](mailto:info@du.ihico.jp)

## Eco-Friendly Product

 **MEIYO ELECTRIC CO., LTD.**

<http://www.meiyoelc.co.jp/>



TF-Detector is one of the best way for monitoring the friction of cylinder liner. The product helps to optimize the usage of lubricant. For example, a bulk carrier consumes several hundred thousand USD for lubricant per year. By using TF-Detector for reducing even few percentage of lubricant can save costs a lot.

By measuring the ferrous powder contained in drain oil, we foresee the disorder of machines caused by friction. Also can help to judge when to maintain the machine or use lubricant.

-Online type: Install on the pipe of drain oil to realize real-time monitoring.

-Portable type: Can test various points by one set.

Easy operation. Data can be saved to PC for analysis.

●Features:

1.High Resolution: The magnetic particle density is test per PPM.

2.No running cost: No consumables happening when testing.

3.Easy to operate: 3 steps to operate the portable type.

-Input test sample to tube

-Insert the tube to machine

-Press one button to start test.

■Operating video is available: <https://youtu.be/KI2uK7f1SUl>



### INQUIRIES

MEIYO ELECTRIC Co., Ltd. Sales Department

Tel : +81-54-345-2212

E-mail : sal-shimizu@meiyoelc.co.jp

Eco-Friendly product, Garbage Compactor

## Eco-Friendly Product

 **MOL Techno-Trade, Ltd.**

[http://www.motech.co.jp/e\\_index.html](http://www.motech.co.jp/e_index.html)

**AIR GARBAGE COMPACTOR Type AGC- III**



MOL Techno-Trade, Ltd. newly developed air actuate Garbage Compactor AGC-III which can compress various waste materials such as plastic film, bottle and beverage cans by using compression air onboard. Simple design with easy and safe operation will be much effective for organizing waste materials. AGC-III can also reduce the waste disposal cost.

### INQUIRIES

**MOL Techno-Trade, Ltd. / Ship's Supplies & Machinery Dept.**

1-1, 1-Chome, Kyobashi, Chuo-ku, Tokyo, 104-0031, Japan

Tel : +81-3-6367-5370 Fax : +81-3-6367-5515

Email : ship-mach@motech.co.jp

# Engine Telegraphs & Loggers

## KEI<sub>system</sub> KEI SYSTEM CO., LTD.

<http://www.kei-system.co.jp/indexe.html>

### Fuel consumption meter

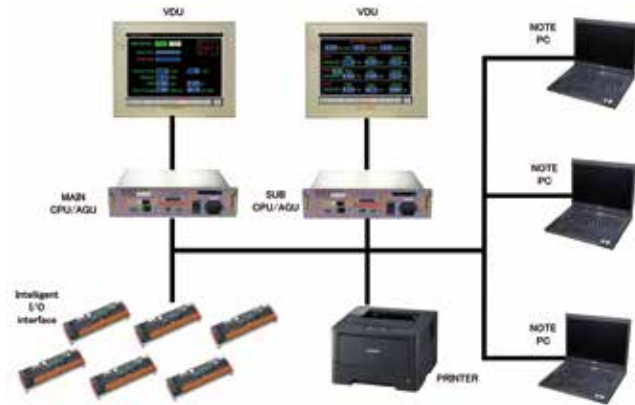

Our data logger system is possible to display the following information by connecting with GPS by serial communication.

Confirm the fuel cost in real time inboard.

- Fuel consumption rate per day. (Tonnage)
- Distance of cruise per a ton of fuel. (Mile)
- Fuel consumption rate per hour.
- Possible to display and to record the fuel consumption rate etc. per a navigation.

### INQUIRIES

1-5, 1-Chome, Ikunonishi, Ikuno-Ku, Osaka, 544-0024, Japan  
 Tel : +81-6-6712-1151 Fax : +81-6-6712-1311  
 E-mail : info3@kei-system.co.jp

### Exhaust Gas Heat Recovery Unit

# Exhaust Gas Heat Recovery Unit

## MIURA MIURA CO., LTD.

<http://www.miuraz.co.jp/en/bwts/>

### GK-G



The GK-G exhaust gas heat recovery unit works with a composite boiler to recover the waste heat from the G/E for use as a heat source. It can contribute significantly to saving space and reducing fuel costs. Air pollution regulations in the IMO MARPOL Convention have resulted in changes in the conditions for exhaust heat recovery and in future, it is anticipated that the amount of steam produced will be insufficient.

The GK-G makes effective use of the normally unused exhaust heat from auxiliary generators, enabling it to be used as a heat source.

### INQUIRIES

7 Horie-cho, Matsuyama, Ehime, 799-2696, Japan  
 Tel : +81-89-979-7060 Fax : +81-89-979-7082  
 E-mail : hakuyo\_eka@miuraz.co.jp



# Fire Fighting System (World's First Truly Sustainable Fire Fighting System)

**Port Enterprise Co., Ltd.**  
*Sailing into the future*

## Port Enterprise Co., Ltd.

<http://www.portenterprise.com>

### 100% Pure Electric Ferry



4.3MW Largest Marine Lithium Battery Energy Storage System



### Zero Emission Autonomous Ship



### PCC for TESLA Electric Vehicles



100% Natural and Biodegradable  
Non-Corrosive/Toxic  
Expansion Foam Based

## FIFI4MARINE

Marine Certified Fire Fighting System



## INQUIRIES

No. 2-1-28, Chikko, Minato, Osaka, 552-0021, Japan  
Tel : +81-6-6573-5391 Fax : +81-6-6575-3036  
E-mail : penterj@penterj.co.jp

# Fresh Water Generating Plant

## SASAKURA ENGINEERING CO., LTD.

<http://www.sasakura.co.jp/e/index.html>

### Double Effect Fresh Water Generator Series WX



Futures of the series WX.

- ① Almost double the desalination efficiency of the series X  
The same capacity of fresh water with a half energy consumption, compared with the series X (single stage type).
- ② Hinge-type turning heater for easier maintenance & inspection
- ③ Easy replacement from existing unit  
Split Type to carry in the ship easily (option)

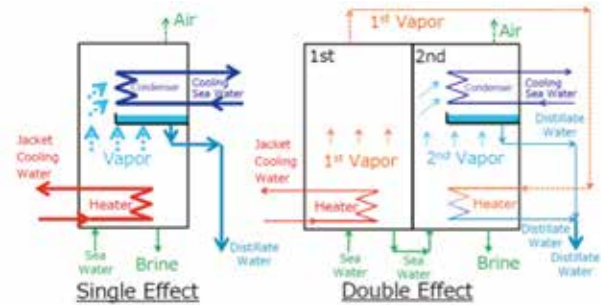

### INQUIRIES

7-32, 4-chome, Takejima, Nishiyodogawa-ku, Osaka, 555-0011, Japan  
 Tel : +81-6-6473-2134  
 E-mail : marine@skm.sasakura.co.jp

# Fresh Water Generating Plant

## SASAKURA ENGINEERING CO., LTD.

<http://www.sasakura.co.jp/e/index.html>

### Vacuum Vapor Compression Shell & Tube Evaporation Type Fresh Water Generator



The VVC distiller system has four main components; a horizontal-tube, thin-film evaporator; a rotary blower and a back-up heater. Vacuum in the unit is maintained by a small vacuum pump.

Features:

- Scale-free horizontal tubular evaporator
- Maintenance-free & compact type heat-pump
- Evaporation can be operated by only electricity.

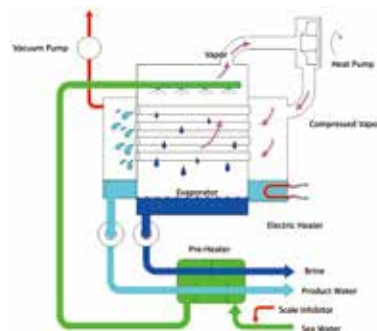

### INQUIRIES

7-32, 4-chome, Takejima, Nishiyodogawa-ku, Osaka, 555-0011, Japan  
 Tel : +81-6-6473-2134  
 E-mail : marine@skm.sasakura.co.jp

# Fuel Reformer



**Port Enterprise Co., Ltd.**

<http://www.portenterprise.com>

## FENIC Alpha Fuel Reformer

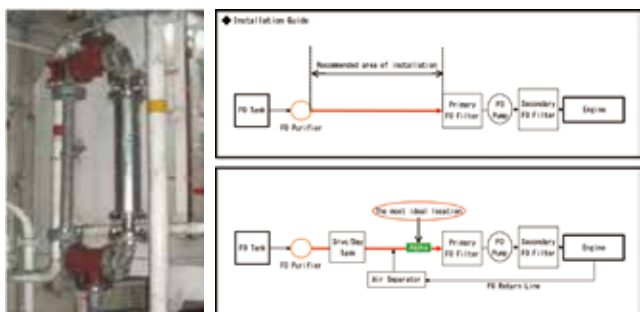
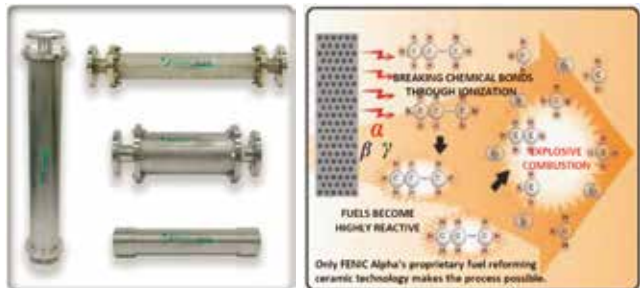

FENIC Alpha upgrades a variety of fuels by breaking chemical bonds of complex hydrocarbons through ionization using our own proprietary ceramic technology.

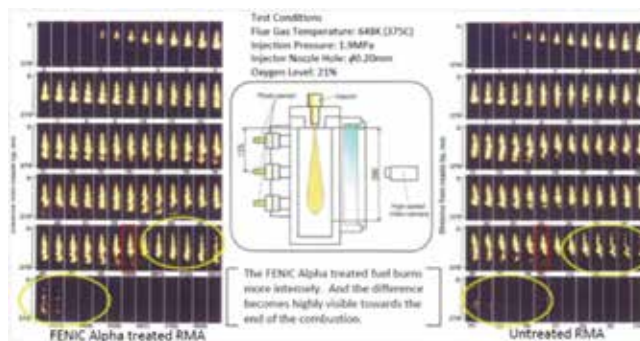

It is well proven, completely safe, extremely easy to install, and requires absolutely no power source.

## INQUIRIES

No. 2-1-28, Chikko, Minato, Osaka, 552-0021, Japan  
 Tel : +81-6-6573-5391 Fax : +81-6-6575-3036  
 E-mail : penterj@penterj.co.jp

It is the result of pursuing simplicity.

# FreshWater Producing Unit



**KURITA WATER INDUSTRIES LTD.**

<http://www.kurita.co.jp/English>



KURITA was established in 1949, and since then KURITA has accumulated many know-hows and technologies on water treatment in land-based industries and is today recognized as a global company which provides comprehensive solutions in various markets.

This time, it is our great pleasure to introduce KURITA SERVE MASTER, a newly developed freshwater producing unit using RO (Reverse Osmosis) membrane technology particularly for the maritime field.

«Feature of KURITA SERVE MASTER»

- 1) High quality of fresh water of Double-Pass RO unit.
- 2) Realizes long term stable operation of RO unit by application of KURITA original slime control agent KURIVERTER IK-110.
- 3) Simple structure for easy Operation and Maintenance.
  - ① Possible to operate with only On/Off switches.
  - ② No need for unnecessary valve operation.
  - ③ Uses high-durability parts.
  - ④ Control system consisting of only Relay and Timer

Let's consider KURITA SERVE MASTER for your next opportunity, and KURITA is available for a detailed explanation anywhere and anytime.

## INQUIRIES

**Next Generation Business Div.,**

Nakano Central Park East, 4-10-1 Nakano, Nakano-ku, Tokyo, 164-0001 Japan  
 Tel : +81-3-6743-5053 Fax : +81-3-3319-2012  
 E-mail : kurita\_marine@kurita.co.jp



# Galley Relative Equipment

## HSN-KIKAI KOGYO CO., LTD.

<https://www.hsn-kikai.com/en/>

### Hydroponic Equipment



- **160 pots of harvested green vegetable per 1 cycle (80 dishes of 15g "Baby Leaf" salad)**  
"Baby Leaf" grows fast and can be harvested in about 3 weeks. Over 20 kinds of green vegetables can be cultivated.
- **Cultivated by auto-control of liquid fertilizer**  
Liquid fertilizer concentration is monitored by sensor and properly adjusted automatically by tube pump.
- **Easy maintenance**  
Urethane coated cultivating tray is hygienical and don't need any special tool for maintenance.
- **LED as light source**  
LED is appropriate to photomorphogenesis and growth promotion.
- **No worry about rolling and pitching**  
Can cultivate onboard without water leak even when vessel is operating.

### INQUIRIES

1-5-30, Furuta, Harima-cho, Kako-gun, Hyogo, 675-0146, Japan  
Tel : +81-79-436-3001 (Head Office), +81-78-391-2751 (Sales Dept.)  
E-mail : overseas@hsn-kikai.com

# Gas Combustion Unit

## VOLCANO CO., LTD.

<http://www.volcano.co.jp/english/index.html>

### Gas Combustion Unit for LNG Fueled vessel "MECS-GCU"



This system "MECS-GCU" can process Boil Off Gas(BOG) in the range from 250kW to 2400kW for LNG Fueled vessels which are expected to increase.

This system safely incinerates and processes BOG or Gas vaporized when bunkering on LNG Fueled vessels. When docking a LNG Fueled vessel, combustible gas in the fuel tank should be incinerated and replaced to inert gas. This system can incinerate various BOG consisting of CH<sub>4</sub> or inert gas.

On LNG Fueled vessels, BOG would be generated. CH<sub>4</sub>, which is main component of BOG, is 25 times more potent than CO<sub>2</sub> for global warming. "MECS-GCU" makes it possible to process CH<sub>4</sub> without emitting into the atmosphere.

### VOLCANO has 90years History.

We have more than 38years experiences of LNG Fuel for marine use.

We have delivery records for more than 190 vessels and have a reputation as safe and secure.

### INQUIRIES

**Sales Department, Combustion Engineering Division**  
1-3-38 Nonaka-kita, Yodogawa-ku, Osaka, 532-0034, Japan  
Tel : +81-6-6392-5541 Fax : +81-6-6396-7609  
E-mail : info-m@volcano.co.jp

# Gas Engine

**Kawasaki**  
Powering your potential

**KAWASAKI HEAVY INDUSTRIES, LTD.**

<http://global.kawasaki.com/en/mobility/marine/machinery/mge.html>

## Green Gas Engine (L30KG)



In April 2014, Kawasaki Heavy Industries, Ltd. obtained the type approval certificate from DNV-GL for Green Gas Engine L30KG — the main engine for large vessels fueled solely by gas with an output capacity of over 2 MW.

Green Gas Engine L30KG can reduce emissions far below the level set by IMO NOx Tier III regulations without relying on special equipment such as an SCR (Selective Catalytic Reduction) system. Its superior environmental performance also allows significant reduction of CO<sub>2</sub> and SOx emissions compared to diesel engines, thus helping marine vessels comply with various environmental regulations.

## INQUIRIES

**Marine Machinery Sales Department**  
1-14-5, Kaigan, Minato-ku, Tokyo, 105-8315, Japan  
Tel : +81-3-3435-2374 Fax : +81-3-3435-2022  
E-mail : marine-machinery-sales-e@khi.co.jp

# Hydraulic Control Valve

**Nabtesco** Nabtesco Corporation

<https://www.nabtesco.com/en/>

## FIVA(Fuel Injection and Valve Actuation) Valve



FIVA valve is an electro-hydraulic servo valve which controls fuel oil injection timing, quantity and exhaust valve actuation timing in order to optimize combustion condition at any load. This is applied to MAN Energy Solutions ME (electric controlled) two-stroke engine and installed on each cylinder. This contributes to eco-friendly engine actuation with fuel-efficient and low-emission.

We, Nabtesco, developed our own a high-precision pilot valve and a feedback sensor that bring high-quality and high-reliability. Furthermore, we offer its condition check and overhaul services as part of maintenance through our world-wide service network for your safety voyage.

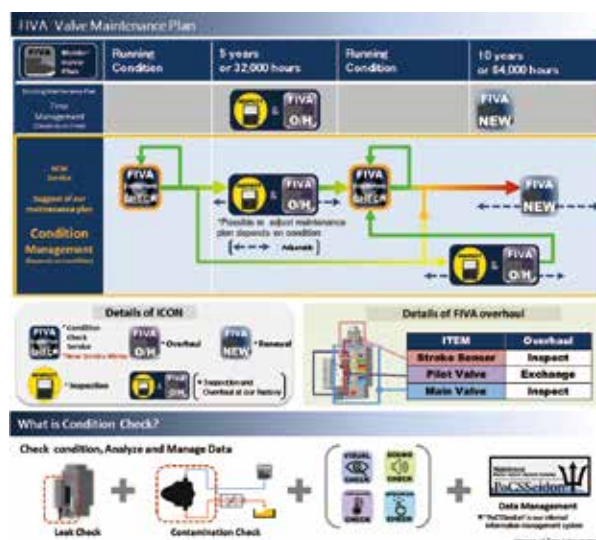

## INQUIRIES

**Marketing & Sales Department, Marine Control System Company**  
1617-1, Fukuyoshidai 1-chome, Nishi-ku, Kobe, Hyogo, 651-2413, Japan  
Tel : +81-78-967-5361 Fax : +81-78-967-5362  
E-mail : newbuilding@nabtesco.com

# LNG Pump

**SHINKO IND. LTD.**

<http://www.shinkohir.co.jp/en/>

## LNG Pump



In anticipation of the growing need for safe and clean energies, our company began developing low-temperature liquefied gas pumps in the 1970's.

In 1992, we supplied our first marine LNG pumps to a LNG carrier. Since then, our global market share has increased and now reached over 85%. These LNG pumps have become one of our main products that supports our company, much like our cargo oil pumps. Our LNG pump specifications can adapt to the shale gas energy revolution and other new demands, allowing us to receive a high reputation from customers worldwide.

## INQUIRIES

Department : Business Dept. 1  
 5-7-21 Ohzu, Minami-ku, Hiroshima, 732-0802, Japan  
 Tel : +81-82-508-1000  
 E-mail : master@shinkohir.co.jp

Contribution to Eco-Operation, Fuel Save 84% Cost Down

# Monitoring & Control Systems

**HSN-KIKAI KOGYO CO., LTD.**

<https://www.hsn-kikai.com/en/>

## Cooling Sea Water Control System PiVA

The sea water pump is controlled with optimal speed by inverter based on the temperature information monitored at several points.

By optimizing the pump speed, you can achieve considerable energy savings.

HEISHIN Cooling Sea Water Control System PiVA

### < Cooling System by Pump Speed Control >

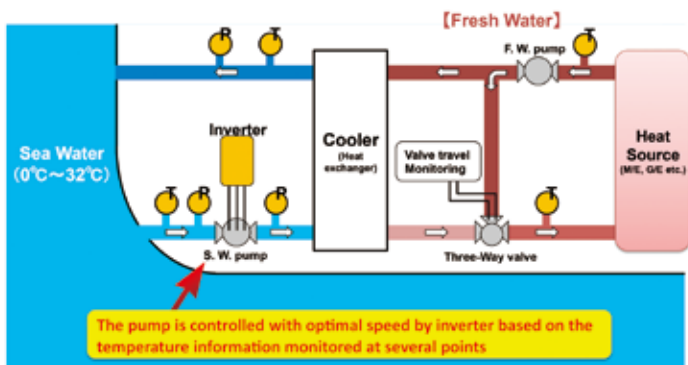

## Ship Performance Monitoring System SPM

Fuel consumption per voyage, M/E revolution and voyage distance are displayed on the monitor, and the data is automatically recorded in SD card. The voyage record sheet is automatically printed out.



## INQUIRIES

1-5-30, Furuta, Harima-cho, Kako-gun, Hyogo, 675-0146, Japan  
 Tel : +81-79-436-3001 (Head Office), +81-78-391-2751 (Sales Dept.)  
 E-mail : overseas@hsn-kikai.com



# Navigation Lights

## NIPPON SENTO CO., LTD.

<http://www.nipponsento.co.jp/>

### LED Navigation Lights Type NL series



Type Approval  
JG NL series

#### ■Highly reliable design of LED light sources

Conditions of the LED are always monitored. If a problem occurs in the LED, the inner circuit detects it, turns off the LED immediately, and sends an error signal to the control panel.

Both the LED light source and frame are highly-reliable and made in Japan.

#### ■Vibration-proof characteristics

Incandescent lamps burn out when vibrations are applied to them. LED lamps will not burn out.

#### ■Projection-free lamp windows

Lamp windows need no projections, such as Fresnel lenses, owing to superior LED light distribution characteristics of LED light sources.

These characteristics reduce possibility of ice coating and snow accretion and prevent adhesion of dust and stain.

#### ■Power saving and long life

The LED light source reduces power consumption down to 1/6 in comparison with the traditional incandescent lamps and allows remarkable power saving.

The rated life of the LED light source is as long as 50000 hours.

#### ■Replaceable light source unit

The LED light source and power supply are unitized and can be replaced easily. Three types have common units, allowing immediate replacement and recovery from problems with the minimum stocks.

### INQUIRIES

555, Takahisa, Yoshikawa, Saitama, 342-0035, Japan

Tel : +81-48-981-2661 Fax : +81-48-981-2664

E-mail : nissen@nipponsento.co.jp

Blue-sea mat ECO, oil absorbents are accepted as the recycled product with ECO Mark by Japan Environmental Association.

# Oil Absorbents

## Shimada & Co., Ltd.

<http://www.shimatonet.co.jp/index-e.htm>

### Blue-sea mat ECO



1. Blue-sea mat ECO is environmental friendly oil absorbents which is mainly made from natural unbleached cotton.
2. Cotton is a natural fiber and it absorbs atmospheric carbon dioxide while it is growing every year and purify the atmosphere. Therefore, even if carbon dioxide is discharged during incineration, it will not be counted as emission amount.
3. Due to superior in absorbent ability, it makes possible low cost and high performance.
4. Due to it has property of absorbing only oil, floating on water after absorbing oil makes easier to collect.
5. Due to using natural fiber, the heating value during incinerating is half of other polypropylene products. Do not worry about the poisonous gas by incinerating.

### INQUIRIES

SHIMADA & CO., LTD. SALES DIVISION OVERSEAS SECTION

No.4-2, 3-Chome, Ichioka, Minato-ku, Osaka, 552-0012, Japan

Tel : +81-6-6574-0908 Fax : +81-6-6574-4601

E-mail : y.imamizo@shimatonet.co.jp

# Paints

## **CMP** CHUGOKU MARINE PAINTS, LTD.

<http://www.cmp.co.jp/global.html>

### SEAFLO NEO CF Z / SEAFLO NEO CF PREMIUM

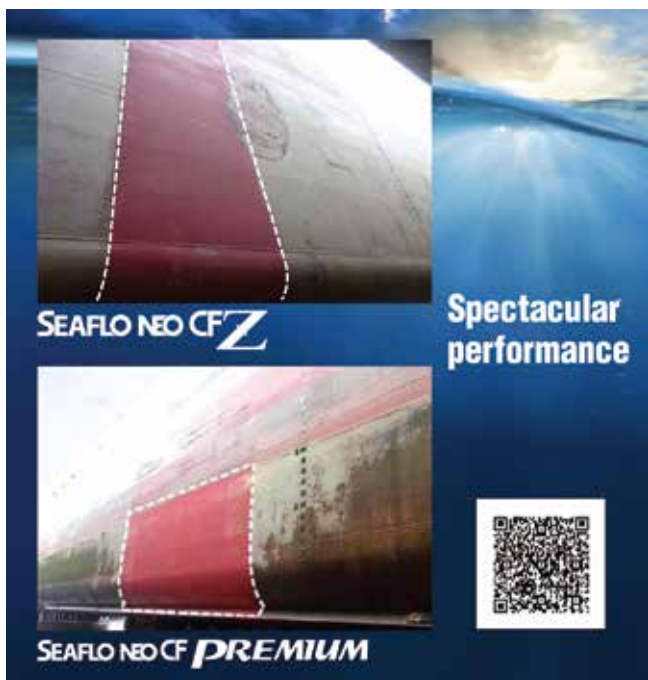

### PREMIUM ANTIFOULING PERFORMANCE FROM PREMIUM ANTIFOULING TECHNOLOGIES

Since the company establishment in Hiroshima, Japan in 1917, Chugoku Marine Paints, Ltd (CMP). has developed its worldwide network in 35 countries and offer services from more than 105 locations.

SEAFLO NEO CF Z and SEAFLO NEO CF PREMIUM are premium range of the latest antifouling products from CMP, both provide high performance incorporating a new biocide technology combined with a zinc acrylate polymer.

These products have been designed as a premium solution for vessels trading at a wide range of speed and activity, where the main focuses are long term hull performance, reducing hull resistance and fuel saving by maintaining very thin leached layer.

### INQUIRIES

**Chugoku Marine Paints, Ltd.**  
**Headquarter**

Tel : +81-3-3506-3951

Contact URL : [https://www.cmp.co.jp/global/contact\\_global.html](https://www.cmp.co.jp/global/contact_global.html)

# Paints

## **CMP** CHUGOKU MARINE PAINTS, LTD.

<http://www.cmp.co.jp/global.html>

### CMP BIOCLEAN PLUS



Foul-release coating (FRC) is one of the environmental choices of antifouling and has proven application records since 2003.

“CMP BIOCLEAN” is in the CMP’s silicone FRC product range. Its ultra-smooth surface which is regulated by the rheology control technology provides foul-release performance and fuel efficiency.

“CMP BIOCLEAN HB” is silicone finish coating. Single coat system of silicone finish is the CMP’s unique technique.

“CMP BIOCLEAN PLUS”, the latest version in the CMP BIOCLEAN series, has been newly developed based on CMP BIOCLEAN HB. It’s added “PLUS Technology” induces resisting and releasing slime.

### INQUIRIES

**Chugoku Marine Paints, Ltd.**  
**Headquarter**

Tel : +81-3-3506-3951

Contact URL : [https://www.cmp.co.jp/global/contact\\_global.html](https://www.cmp.co.jp/global/contact_global.html)

# Paints



## NIPPON PAINT MARINE COATINGS CO., LTD.

<http://www.nipponpaint-marine.com>

### A-LF-Sea – Ultra Low Friction Underwater Coating System -

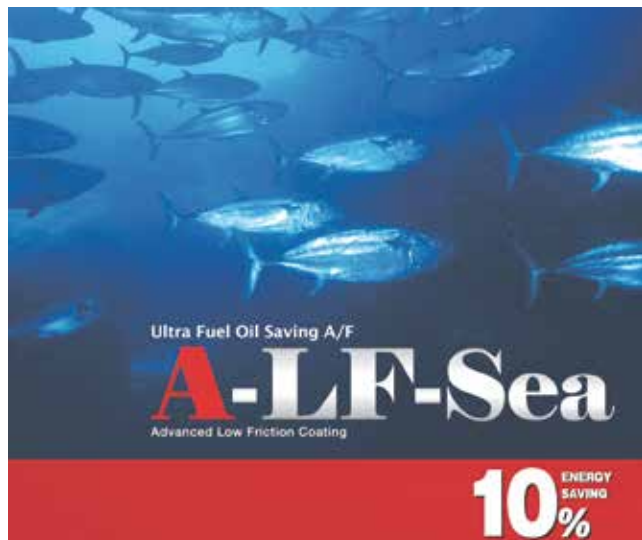

A-LF-Sea is an advanced version of our low-friction coating “LF-Sea” delivering further propulsion benefits.

A biomimetic ultra-low-friction antifouling that works using a patented water trapping function to lower the hydrodynamic footprint of the hull.

Stable and long term antifouling is guaranteed by the use of a low friction copper-silyl-acrylate copolymer.

Used in conjunction with Nippon Paint Marine's 'Rheo' anticorrosive systems, fuel-savings can be further enhanced.

A-LF-Sea provides 10% fuel-saving effect in case of new building or full-blasting at M&R and 7~8% fuel-saving effect in case of spot blasting at M&R to be applied A-LF-Sea only without Rheological anti-corrosive coatings. Over 1100 ships has already been applied with A-LF-Sea in the world as of June 2018. And the number of track records including LF-Sea (1st generation of A-LF-Sea) has reached 2600.

### INQUIRIES

**NIPPON PAINT MARINE COATING CO., LTD.**

Tel : +81-6-6455-9590

Contact URL : [NPM\\_contacts@nippe-marine.co.jp](mailto:NPM_contacts@nippe-marine.co.jp)

# Paints



## NIPPON PAINT MARINE COATINGS CO., LTD.

<http://www.nipponpaint-marine.com>

### SI paint NOA – Protective Coating System with SI (Self-Indication) technology



NOA is Nippon's unique technology providing users for the first time with the ability to judge the correct thickness of the paint. NOA's unique patented technology reduces the need for complicated thickness checking by thickness gauge. NOA contributes to reduce workload for (1) coating inspection, (2) physical thickness measurement & marking and (3) post painting repair & touch-up. Furthermore, NOA contributes to secure (a) uniform coating, (b) specified thickness, (c) minimal excessive thickness and (d) corrosion protection for ship's life.

Especially for WBT, NOA has been applied over 1200 new buildings since 1998. And its 10 year corrosion protection records are recently confirmed on large LNG carriers.

### INQUIRIES

**NIPPON PAINT MARINE COATING CO., LTD.**

Tel : +81-6-6455-9590

Contact URL : [NPM\\_contacts@nippe-marine.co.jp](mailto:NPM_contacts@nippe-marine.co.jp)



# Propeller Boss Cap Fins

**MOL** MOL Techno-Trade, Ltd.

<http://www.pbcf.jp>

## PBCF (Propeller Boss Cap Fins)



PBCF is the pioneer and the best seller in energy saving device installed on a propeller to improve propulsive efficiency by eliminating hub-vortex and by reducing torque loss. In consequence, vessel fuel consumption is reduced up to 5%. PBCF is originally developed by Mitsui O.S.K. Lines in 1987, and advanced PBCF has launched since May 2017. Total number of installation is now over 3,300 vessels in all over the world.

### Principal Benefits of PBCF

- Saving fuel up to 5%, corresponding reduction of NOx and CO<sub>2</sub> emissions.
- Reduces propeller-induced underwater-noise and vibrations.
- Simple and quick installation, just the replacement of the existing propeller boss cap.
- Suitable to both new buildings and retrofit applications.
- Pay-back time is less than 1 year, even at low fuel prices.

## INQUIRIES

### MOL Techno-Trade, Ltd. / PBCF Dept.

1-1, 1-Chome, Kyobashi, Chuo-ku, Tokyo, 104-0031, Japan

Tel : +81-3-6367-5380 Fax : +81-3-6367-5516

E-mail : [pbcf@motech.co.jp](mailto:pbcf@motech.co.jp)

# Propellers, Controllable



## KAMOME PROPELLER CO., LTD.

<http://www.kamome-propeller.co.jp/en>

### CP Propeller



As the torque-rich of main engine caused by the fouling of the hull or the effect of waves and wind can be avoidable by adjusting CPP pitch angle and speed properly through ALC or combination control, when building the vessel, the main engine output can be minimized compared with FPP without considering margin to reduce fuel consumption.

The advantage of CPP for large energy saving is exercised by the shaft generator system driven by main engine with constant speed or the hybrid propulsion system where diesel main engine and electric motor/generator are combined as a propulsion prime mover.

### INQUIRIES

**Business Operation Division, International Department**  
690 Kamiyabe-cho, Totsuka-ku, Yokohama, 245-8542, Japan  
Tel : +81-45-811-2461 Fax : +81-45-811-9444  
E-mail : [info@kamome-propeller.co.jp](mailto:info@kamome-propeller.co.jp)

# Propellers, fixed pitch



## KAMOME PROPELLER CO., LTD.

<http://www.kamome-propeller.co.jp/en>

### SG Propeller

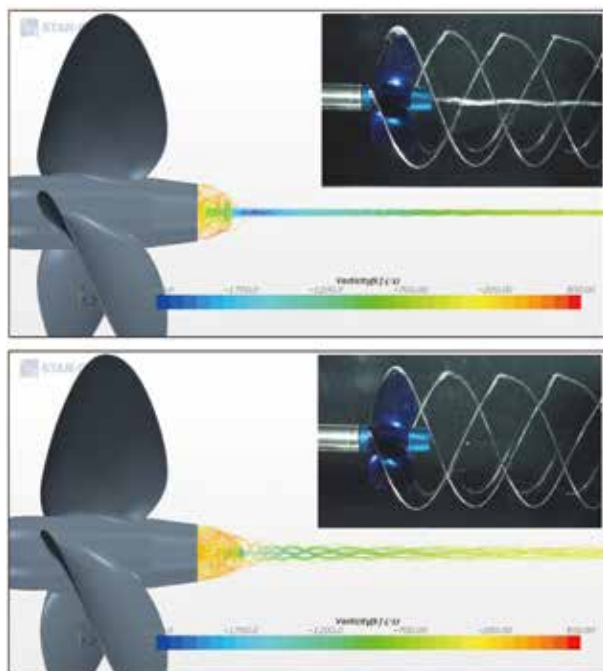

The SG propeller applies the reducing technology of the hub vortex strength and the optimization technology of the blade loading distribution and the numerical calculations including the cavitation simulation, the propeller exciting force estimation, etc. are introduced in its design. The reduced hub vortex strength improves the lower pressure region behind the hub which causes the thrust deterioration. The optimized blade loading distribution increases the propeller open water efficiency without deteriorating the cavitation performance.

Accordingly the SG propeller improves the efficiency about 3% than the conventional propeller and has been installed in over 400 vessels.

### INQUIRIES

**Business Operation Division, International Department**  
690 Kamiyabe-cho, Totsuka-ku, Yokohama, 245-8542, Japan  
Tel : +81-45-811-2461 Fax : +81-45-811-9444  
E-mail : [info@kamome-propeller.co.jp](mailto:info@kamome-propeller.co.jp)

# Propellers, fixed pitch



## NAKASHIMA PROPELLER CO., LTD.

<https://www.nakashima.co.jp/eng/>

### GPX PROPELLER

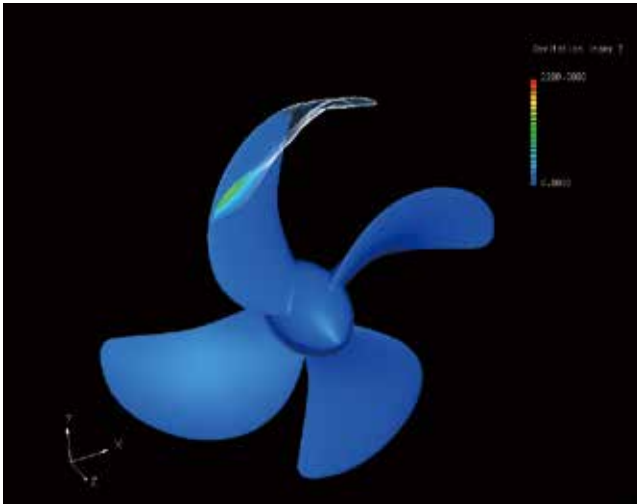

**GPX PROPELLER** is the latest fixed pitch propeller which integrates several design technologies including Non-Hub Vortex, Small blade area, Coordination of Wake distribution and Tip rake.

- Non-Hub Vortex technology can recover energy loss which is caused by hub vortex.
- Small blade area can reduce friction resistance and use CFD analysis.
- Though Wake distribution is different by each vessel, GPX propeller is coordinated based on each wake pattern.
- Tip rake is also developed throughout many model tests and calculations, and now Tip rake can stabilize cavitation and reduce Pressure amplitude.

GPX propeller is optimized by considering balance of those technologies and can achieve higher efficiency.

### INQUIRIES

#### Sales & Marketing Department

688-1, Joto-Kitagata, Higashi-Ku, Okayama, 709-0625, Japan

Tel : +81-86-279-5111 Fax : +81-86-279-3107

E-mail : npcwebmaster@nakashima.co.jp



# Pump



## NANIWA PUMP MFG. CO., LTD.

<http://www.naniwa-pump.co.jp/english/>

### SOx / Nox Scrubber Water Circ. Pump

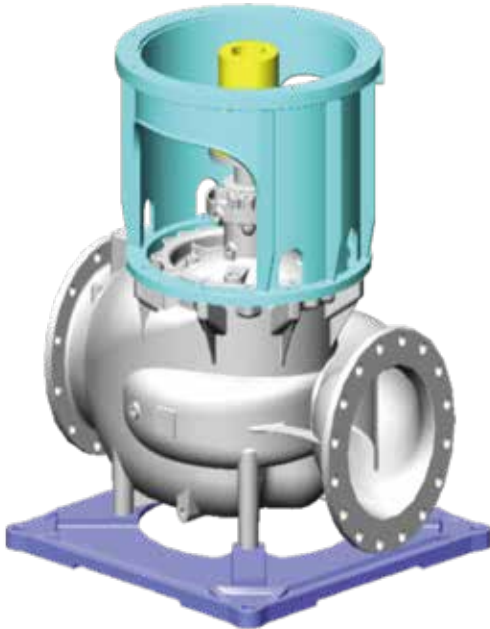

Water Circulating Pump which is designed for NOx & SOx Scrubber System has been developed.

Its features are as follows:

- Specially designed for SOx/NOx Scrubber System.
- All wetted parts are made of stainless steel enduring a wide range of pH value (pH3~11).
- Newly designed diaphragm type mechanical seals in order to resist smoke dust which contaminates the pumping water.

### INQUIRIES

Tel : +81-6-6541-6231

E-mail : [info@naniwa-pump.co.jp](mailto:info@naniwa-pump.co.jp)

### Inverter Control Main Cooling S.W. Pump

# Pump, Inverter Control



## NANIWA PUMP MFG. CO., LTD.

<http://www.naniwa-pump.co.jp/english/>

### NEO-ME

Diagram for Central Cooling System with NEO-ME series

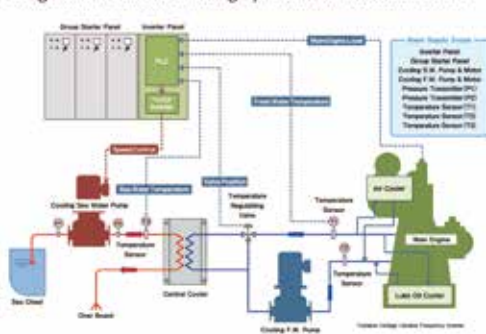

#### How does NEO-ME affect fuel consumption?

■ Fuel Consumption of Generator Engine

334.8 ton/year

88% Less

44.0 ton/year

■ Cash Flow

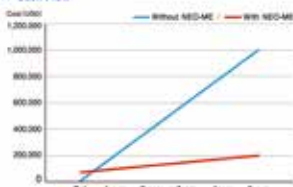

Basic Technical Data

- ① Ship type: Bulk
- ② Inverter Drive Main Cooling S.W. Pump
- ③ Shaft Horse Power at specific Q: 1100kW
- ④ Average Rotational Speed of the pump: 870rpm
- ⑤ 20% of rated speed assumption
- ⑥ Shaft Horse Power at 80% of rated speed: 1070kW
- ⑦ Design Data of Aux. Engine
- ⑧ Rate of fuel consumption: 180g/kWh
- ⑨ Efficiency of generator: 94%
- ⑩ Operation time: Maximum: 7,200 hours per year
- ⑪ Efficiency of inverter: 95%
- ⑫ Electric Motor
- ⑬ Rating: 1000kW
- ⑭ Efficiency: 97%
- ⑮ Approx. Price: USD 500,000

Naniwa Pump supports customer expectation for “greener ships”, paying close attention to the following parameters.

- Environmental Protection
- Safety of Operation
- Saving Energy

NEO-ME series control rotational speed of Main Cooling Sea Water Pump according to following information.

- Main Engine Load
- Sea Water Temperature
- Temperature Regulation Valve Position
- Fresh Water Temperature

NEO-ME series operate Main Cooling Sea Water Pumps with economy and safety. Its standard features are as following:

- High response performance to main engine load
- 0% Speed at 100% F.W. Circulation
- Adaptive to sea water temperature change
- Based on those features NEO-ME series realizes:
- Full time minimum fuel consumption
- Optimized operation for vessel speed reduction

For safety operation:

- Flushing alert system is incorporated.

### INQUIRIES

Tel : +81-6-6541-6231

E-mail : [info@naniwa-pump.co.jp](mailto:info@naniwa-pump.co.jp)

# Pumps, Bilge



<http://www.heishin.jp/en/>

## Heishin PC Pump



Heishin PC Pump is capable of handling high-viscosity fluids, high-concentration slurries and fluids containing solids. As conveyed materials move through pipes, practically no unpleasant odors are produced. Also, it is a quiet pump that makes no drive noise aside from the motor. Heishin PC Pump with these features is best suited for conveyance of bilge water.

## INQUIRIES

Nihombashi Kato Bldg. 8F, 2-1-14, Nihombashi, Chuoh-ku, Tokyo  
103-0027, Japan

Tel : +81-3-5204-6380 Fax : +81-3-5204-6377

E-mail : [info@mohno-pump.co.jp](mailto:info@mohno-pump.co.jp)

# Pumps, Deep Well



[www.taiko-kk.com/en](http://www.taiko-kk.com/en)

## Pumps, Deep Well



The MarFlex-Taiko Deep well Cargo Pump has two remarkable features:

- 1) The Pump uses a motor-driven system to solve the problems of noise and power efficiency that are present in conventional, hydraulic-driven, deep-well cargo pumps.
- 2) The Pump has been designed so that bearing lubrication is isolated, providing a much longer service life.

The lubrication of bearings by liquid cargoes has been a trouble-spot in deep-well cargo pump design.

MarFlex solved this problem by designing a forcedfed lubrication of the bearing, passing the driving shaft through a separate support pipe.

## INQUIRIES

209-1 Shimotabuse, Tabuse-cho, Kumage-gun, Yamaguchi, 742-1598, Japan

Tel : +81-820-52-3113 Fax : +81-820-53-1001

E-mail : Please contact our website

# Reduction Gear

**nico** HITACHI NICO TRANSMISSION CO., LTD.

<http://www.hitachi-nico.jp/en/index.html>

## Reduction Gearbox for Exhaust Power Recovery System

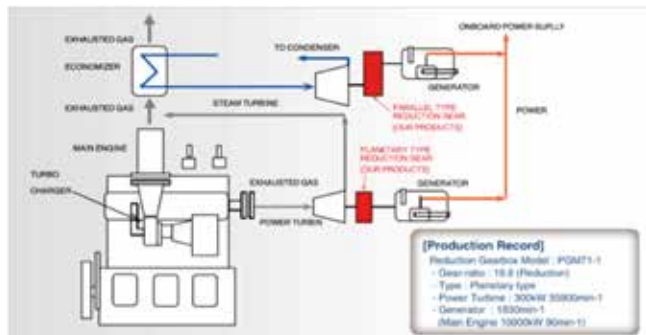

Reduction Gearbox (Model : PGM71)

Exhausted gas from marine diesel engine remains much energy to be recovered.

Our reduction gearbox is used in the exhaust power recovery system with power turbine and steam turbine.

- Light weight and compact design.
- High reliability on many production experience for continuous use high speed turbine.
- Two kinds of type are selectable as parallel-type and planetary-type, depend on turbine speed.

## INQUIRIES

405-3 Yoshinocho 1-chome, Kita-ku, Saitama, 331-0811, Japan  
 Tel : +81-48-652-6708 Fax : +81-48-652-8719  
<https://www8.hitachi.co.jp/inquiry/hitachi-nico/en/form.jsp>

# Rudders



**JAPAN HAMWORTHY & CO., LTD.**

<http://www.japanham.com/en>

## Rudders Super VecTwin System

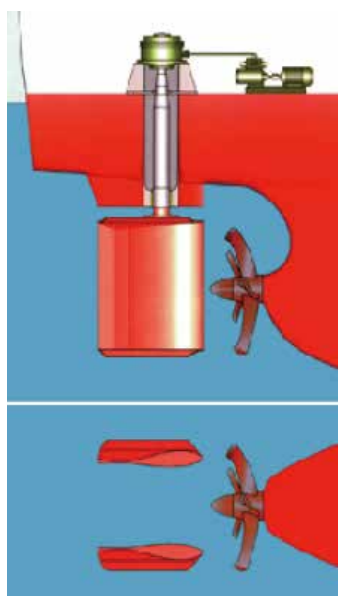

Outline of VecTwin Rudder

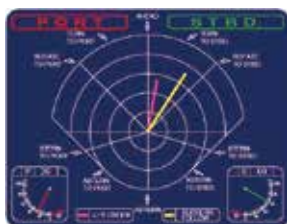

Joystick panel



Example of thrust vector

- Excellent maneuvering system with a pair of high lift rudders fixed behind a propeller.
- Safe navigation maneuverability having any operation mode including going-astern with turning capability, hovering, extra dead slow forwarding, and turning port and starboard, with forward direction propeller revolution, which develop thrust in all directions.
- Improved propulsive efficiency with reaction fins and propeller boss cap fins (PBCF) which removes propeller hub vortex.
- Function of easy and short-time approaching to and departing from berth reduces mental and physical hardships of crew, which brings an excellent economical effect.
- An emergency stop which reduces the stopping distance to about a half of that of a conventional ship.

## INQUIRIES

Omodaka Bldg., 1-15-1, Shigino-nishi, Joto-ku, Osaka, 536-0014, Japan  
 Tel : +81-6-6962-8877 Fax : +81-6-6962-8899  
 E-mail : [jhc@japanham.co.jp](mailto:jhc@japanham.co.jp)



# Rudders, High Lift



## KAMOME PROPELLER CO., LTD.

<http://www.kamome-propeller.co.jp/en>

### K-7 Rudder



M Type

M2 Type

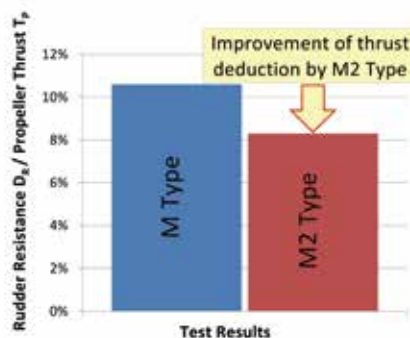

The K-7 Rudder consists of the main rudder and the flap fitted to the rudder with hinge. As the flap turns more than 2 times of the main rudder angle during steering, the lift generated in the propeller slip stream is higher than the conventional rudder by the effect of the camber composed by the main rudder and the flap. As the K-7 rudder area required to attain the same turning performance becomes smaller than the conventional rudder required for the same ship, K-7 rudder makes the rudder resistance reduced and contributes to the energy saving.

### INQUIRIES

**Business Operation Division, International Department**  
 690 Kamiyabe-cho, Totsuka-ku, Yokohama, 245-8542, Japan  
 Tel : +81-45-811-2461 Fax : +81-45-811-9444  
 E-mail : info@kamome-propeller.co.jp

# Seals, sterntubes

## KEMEL EAGLE INDUSTRY CO., LTD.

<https://http://www.kemel.com/>

### Tandem Type EVK Seal

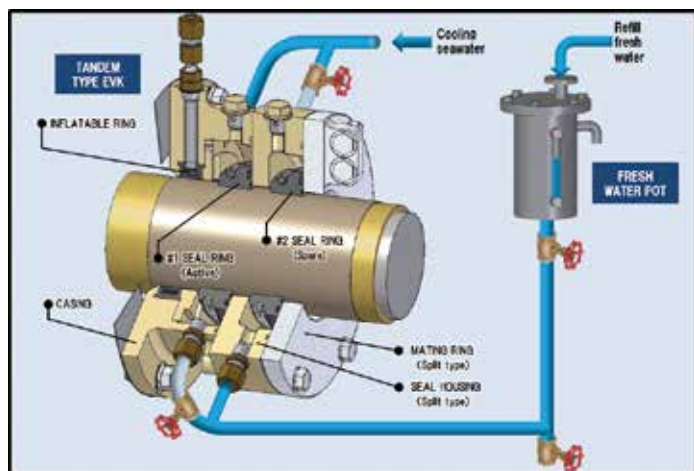

Utilizing our expertise and know-how built over the years, and as the world leader in innovation, KEMEL has recently launched a new water lubricated stern tube seal called "Tandem Type EVK Seal". This new product greatly contributes to safe navigation and environmental conservation.

### FEATURES

- **Improved Wear Resistance**  
 The active #1 seal ring is always lubricated by self-controlled clean fresh water. This results in a significant reduction in wear of the mating ring, seal housing and seal ring.
- **High Operability**  
 The spare #2 seal ring can be easily activated only by closing the valves without disassembling the seal unit.
- **Easy Upgrade from Existing EVK**  
 Converting an existing EVK seal into a Tandem type can be easily done just by adding another seal housing. (Ask KEMEL for more details.)

### INQUIRIES

**Eagle Industry Co., Ltd. KEMEL Tokyo Branch**  
 Tel : +81-3-3436-4830  
 E-mail : sales.tokyo@kemel.com, info@ekk.co.jp

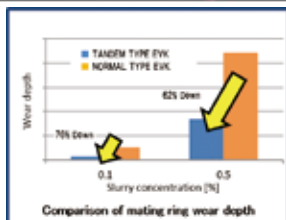

# Selective Catalytic Reduction System

**NIIGATA POWER SYSTEMS CO., LTD.**

<http://www.niigata-power.com/english/index.html>

## Selective Catalytic Reduction System

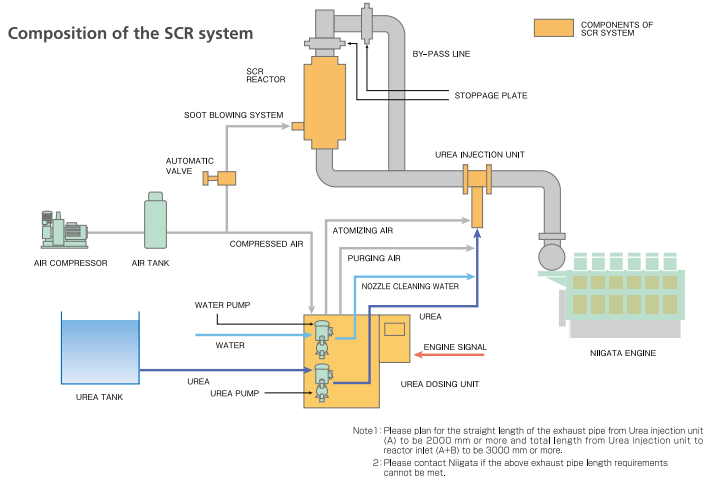

- Niigata has developed marine SCR compliant with the NOx Tier III enforced by the IMO, and prepared SCR for each engine (550 to 6600kW) as the line-up.
- Niigata has delivered the first SCR system for the marine propulsion engine in 1995, nearly 20 years ago, which is still working. Based on such experiences, Niigata started to supply SCR which can be apply to not only new building ships but also existing ships.
- Development of this SCR system utilizes the part of technologies and findings for compact design in the research undertaken by Niigata for “Super-clean Marine Diesel” Project of the JSMEA.
- IHI Power Systems Co., Ltd. (planned) is its new trade name from July, 2019.

## INQUIRIES

14-5, Sotokanda 2-Chome, Chiyoda-ku, Tokyo, 101-0021, Japan  
 Tel : +81-3-4366-1226 Fax : +81-3-4366-1310  
 E-mail : info1\_sales1@niigata-power.com

## Environmental Technologies

# Selective Catalytic Reduction System

**YANMAR YANMAR CO., LTD.**

<https://www.yanmar.com/global/marinecommercial/>

## Selective Catalytic Reduction System

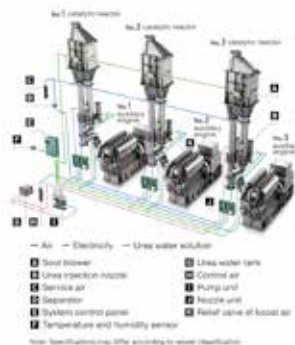

The SCR System with Three Unit Engine Installations



YANMAR developed SCR System that meets to IMO Tier3 regulations.

Making use of our original technology and wealth of experience, we have created a system whose design and functionality are optimized for marine vessels, and which is perfectly matched for use with diesel engines, both in ECA and non-ECA waters. In addition, repeated verification tests have been conducted on ocean-going vessels (equipped with SCR systems for 3 auxiliary engines) to further improve the system.

- The by-pass branching section and catalytic reactor have been integrated into a single unit, achieving high-performance NOx reduction. Engines equipped with our SCR system is obtained NOx certification (Scheme A), whilst maintaining performance onboard.
- Control unit integrates all devices including catalytic reactors mounted to each individual engine. A single pump unit and control panel can manage system for multiple engines, allowing the system to remain compact.

## INQUIRIES

**No.1 Sales Group Overseas Sales Division**  
**Marine Products Sales and Marketing Division**  
**Power Solution Business**  
 1-1-1, Nagasu Higashidori, Amagasaki, Hyogo, 660-8585, Japan  
 Tel : +81-6-6489-8042 Fax : +81-6-6489-1082  
 E-mail : ichiro\_fuwa@yanmar.com

# Separators, Oil & Water

## HSN-KIKAI KOGYO CO., LTD.

<https://www.hsn-kikai.com/en/>

### 15ppm Bilge Separators



Our equipment having the following feature separates the bilge into oil and clean water which is less than 15ppm and available to be discharged into sea according to IMO regulation.

#### 1. Easy internal cleaning

The whole surface can be opened, because maintenance can be conducted easily.

#### 2. All one way entry and exit points

Installation is easy as all the pipes of bilge inlet, processed water outlet, separated oil outlet are in the same direction.

#### 3. World's smallest oil-water separator

Easy replacement and installation as it can be retrofitted within the existing equipment installation space due to its compact design.

## INQUIRIES

1-5-30, Furuta, Harima-cho, Kako-gun, Hyogo, 675-0146, Japan  
Tel : +81-79-436-3001 (Head Office), +81-78-391-2751 (Sales Dept.)  
E-mail : [overseas@hsn-kikai.com](mailto:overseas@hsn-kikai.com)

# Sewage Treatment Equipment

## SASAKURA ENGINEERING CO., LTD.

<http://www.sasakura.co.jp/e/index.html>

### Biological type Sewage Treatment Plant



The vessel discharge restrictions of the International Convention for the Prevention of Pollution from Ships are not limited to oil, but rather control sewage as well.

Sasakura's Sewage Treatment Plant has met to IMO(International Maritime Organization) regulation, MEPC. 227(64).

#### ◆ Flow Diagram

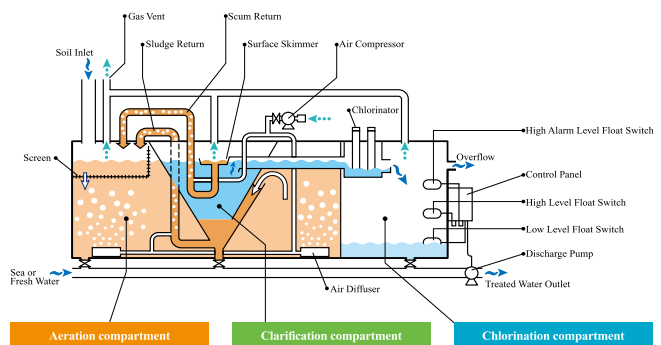

## INQUIRIES

7-32, 4-chome, Takejima, Nishiyodogawa-ku, Osaka, 555-0011, Japan  
Tel : +81-6-6473-2134  
E-mail : [marine@skm.sasakura.co.jp](mailto:marine@skm.sasakura.co.jp)



# Sewage Treatment Equipment

**TAIKO** TAIKO KIKAI INDUSTRIES CO., LTD.

[www.https://www.taiko-kk.com/en](https://www.taiko-kk.com/en)

## Sewage Treatment Equipment



Our SBH series of marine sewage treatment plants are small, high-performance items that were developed by incorporating the sewage treatment technology we developed over many years in the business.

The products in the SBH series can be used on all ships with more than 400 gross tons and a crew of at least 15 as specified in Annex IV of the Marpol 73/78 Treaty.

We've also simplified operation and maintenance.

## INQUIRIES

209-1 Shimotabuse, Tabuse-cho, Kumage-gun, Yamaguchi, 742-1598, Japan

Tel : +81-820-52-3113 Fax : +81-820-53-1001

E-mail : Please contact our website

## Inverter Energy Saving

# Shaft Driven Generating System

**NSDK** NISHISHIBA ELECTRIC CO., LTD.

<http://www.nishishiba.co.jp/nsdk/index.htm>

## Shaft Driven Generating System



The shaft generating system driven by a high-efficiency main engine enables energy saving.

Operation of the shaft generating system reduces the operation time of the diesel generator engine, resulting in maintenance work saving.

## INQUIRIES

**NISHISHIBA ELECTRIC CO., LTD. Osaka Branch**

29th Fl., Umeda Sky Building West Tower, 1-30 Oyodonaka 1-chome, Kita-ku, Osaka, 531-6129, Japan

Tel : +81-6-4797-2451 Fax : +81-6-4797-2453

## Ship and Marine Batteries



# ECO MARINE POWER CO., LTD.

<http://www.ecomarinepower.com/>

### UltraBattery®



In co-operation with The Furukawa Battery Company of Japan, Eco Marine Power is able to supply a range of energy storage solutions and marine batteries for use on ships or for hybrid marine and offshore applications. Battery technologies include the Furukawa Cycle Power (FCP) series and UltraBattery® series. The high quality and long life batteries from Furukawa Battery can be supplied either as part of an integrated marine or ship renewable energy solution or supplied as stand-alone battery packs (with cables) or individual units

- Energy storage for Aquarius Marine Solar Power
- Energy storage for marine or coastal Photovoltaic (PV) systems.
- Emergency back-up power storage
- Energy storage for offshore renewable energy facilities.
- Land-based renewable energy projects.

### INQUIRIES

Aqua Hakata 5F, 5-3-8, Nakasu, Hakata-ku, Fukuoka, 810-0801, Japan  
Tel : +81-92-287-9677 Fax : +81-92-287-9501  
E-mail : [enquiries@ecomarinepower.com](mailto:enquiries@ecomarinepower.com)

Solar power, renewable energy

## Ship and Marine Solar Power



# ECO MARINE POWER CO., LTD.

<http://www.ecomarinepower.com/>

### Aquarius Marine Solar Power



Aquarius Marine Solar Power is an integrated renewable energy system for ships that includes a computer monitoring system, energy storage & a marine-grade solar power array. The energy collected via the solar panel array or string of photovoltaic (PV) panels can be used to power a DC load, provide back-up power or be connected to an AC load via an inverter. This system allows any type of ship to use solar power as an emissions free source of energy and provide an additional source of back-up power for emergency use.

- Emissions free source of power
- Class-approved high quality batteries supplied by The Furukawa Battery Company.
- System can be installed on any type of ship.
- Low maintenance, reliable and robust.
- Special mounting frames for use on ships available.
- Suitable for retrofitting or new shipbuilding projects.
- System design service available.
- Installation support available world-wide.

### INQUIRIES

Aqua Hakata 5F, 5-3-8, Nakasu, Hakata-ku, Fukuoka, 810-0801, Japan  
Tel : +81-92-287-9677 Fax : +81-92-287-9501  
E-mail : [enquiries@ecomarinepower.com](mailto:enquiries@ecomarinepower.com)

# SOx Scrubber



Serving the maritime industry worldwide since 1968

**Port Enterprise Co., Ltd.**  
Sailing into the future

**Port Enterprise Co., Ltd.**

<http://www.portenterprise.com>

## ME Production SOx Scrubber



ME Production SOx scrubber is 100% order made in order to ensure its efficacy as well as easy installation. Both the size and shape can be tailored to match any vessel without compromising its performance.

In addition to that, this award-winning system offers options of Na<sub>2</sub>CO<sub>3</sub> and MgO for alkaline chemical along with conventional NaOH. Both Na<sub>2</sub>CO<sub>3</sub> and MgO can be carried in powder instead of liquid. They are totally safe, easy to handle, and less expensive than NaOH.



ME Production SOx scrubber can also be catered for special needs, such as "Open Loop Plus" with optional active alkaline chemical dosing function to operate in freshwater/low salinity water areas or where strict pH discharge limit applies, containerization of wash water processing system for retrofit projects or vessels with rather limited space, and many more, limited only by your imagination.

## INQUIRIES

No. 2-1-28, Chikko, Minato, Osaka, 552-0021, Japan  
Tel : +81-6-6573-5391 Fax : +81-6-6575-3036  
E-mail: [penterj@penterj.co.jp](mailto:penterj@penterj.co.jp)

TORM L-Class MR2  
Main Engine x 1  
Aux Engine x 4  
Boiler x 2  
Open Loop  
(Hybrid Ready)



## EGCS, The world smallest SOx scrubber

# SOx Scrubber(EDCS) & Laser Gas Analyzer

**Fuji Electric FUJI ELECTRIC CO., LTD.**

<http://www.fujielectric.com>

## Marine Exhaust Gas Cleaning System / SAVEBLUE



Laser gas analyzer



### ◇SOx Scrubber

Fuji's exhaust gas cleaning system (EGCS) consists of cyclone "SOx scrubber" and "laser gas analyzer" developed for marine environmental protection by innovative technologies. The first commercial unit has been delivered October 2018 with high reputation in marine industry where high grade quality control is indispensable. More than 50 orders have been received over the world. Fuji Electric contributes marine environment with innovative solution.

- Compact Design
- Low Maintenance
- Low Pressure Loss

### Laser gas analyzer (SO<sub>2</sub>/CO<sub>2</sub>)

Fuji's laser gas analyzer has been developed for marine use with stable performance and high reliability under harsh environment. In addition, it facilitates low maintenance with superior long term stability without frequent calibration.

- Features
- Occupying less space gives it a major advantage with easy installability
  - Stable performance & longer maintenance cycle
  - Long term stability(Zero drift:  $\leq \pm 1\%$  FS/ 3 months)

## INQUIRIES

Gate City Ohsaki, East Tower 11-2, Osaki 1-chome, Shinagawa-ku, Tokyo 141-0032, Japan  
Tel : +81-3-5435-7168 Fax : +81-3-5435-7475  
E-mail : [mita-itsuro@fujielectric.com](mailto:mita-itsuro@fujielectric.com)



# Turbochargers



## Turbo Systems United CO., LTD.

<http://www.turbo.co.jp/doc/eng/>

### Power2® 800-M



Power2® 800-M is ABB's second-generation two-stage turbocharging system designed right from the start to deliver all the benefits of a dedicated two-stage turbocharging solution.

Power2® 800-M achieves turbocharging efficiencies of more than 75 percent and provides charge air pressure of up to 12 bar, and that's a new industry benchmark, making it the most powerful turbocharging system available in the market.

This translates to potential for double-digit increases in power output density and six-figure annual fuel savings. At the same time contributing to significantly reduced NOx emissions.

Combining the capability for Valve Control management(VCM®) to control air intake with the increased turbocharging efficiency of a two-stage turbocharging solution, additional engine efficiency gains are possible. The combination of two-stage turbocharging and VCM® ultimately enables higher output and a number of key benefits for operators.

Two-stage turbocharging is a key technology in enabling significantly reduced fuel consumption and emissions, in addition to increased engine power density.

### INQUIRIES

#### Turbo Systems United Co., Ltd. Tokyo Office

ThinkPark Tower 22F 2-1-1, Osaki, Shinagawa-ku, Tokyo 141-6022

Tel : +81-3-4523-6900

E-mail : [tsu\\_general@turbo.co.jp](mailto:tsu_general@turbo.co.jp)

### Energy Saving

# Turbochargers



<https://www.mhi-mme.com/>

**MET Turbochargers are the standard worldwide exhaust gas turbochargers used in large marine and stationary engines.**



#### NEW Radial Turbocharger MET-ER Series

The MET-ER Series has been developed based on high pressure ratio requirements for turbochargers, in order to improve the performance of and reduce the NOx emissions of four stroke engines. This turbocharger further increases the pressure ratio of the previous MET-SRC Series and can support a maximum compressor pressure ratio of 6.0. The series features seven types, and a single turbocharger can handle engine outputs from approximately 500 kW to 5,800 kW. Furthermore, the series features improved responsiveness and reduces the number of parts to achieve a more compact design and increase maintainability. MET-ER turbochargers will be released to the market after conducting tests with engine manufacturers this year.



#### New Axial Turbocharger MET-MBII Series

The new MET-MBII Series launched this year provides turbochargers that are one or two models more compact when compared to previous models with the same engine output, thanks to its larger impeller capacity. In order to maintain high efficiency while achieving a large capacity, a new compressor impeller with an optimized blade count and blade angle distribution has been developed for the MET-MBII Series. Furthermore, the series also adopts a new turbine with optimized turbine blade throat distribution. On the other hand, casing components except for the silencer have not been changed from the previous MET-MB Series, which enables the product to inherit the high reliability and maintainability of that series.

### INQUIRIES

#### Tokyo Branch Office

Tel : +81-3-6716-5331 E-mail : [info\\_meet@mhi-mme.com](mailto:info_meet@mhi-mme.com)

# Winches, mooring, electric & hydraulic



**MANABE**  
IMABARI JAPAN

**MANABE ZOKI CO., LTD.**

<http://manabezoki.co.jp/>

## Electric deck machinery driven by Inverter



Our electric deck machinery is driven by inverter system which enables you to operate Windlass and Mooring winch very smoothly and easily. In addition to eco-friendly owing to no use of working oil, by adopting our own sampling-controlled AUTO TENSION system, ship can keep the mooring position in stable condition even though changing marine tide or loading quantity on board. Sampling-controlled AUTO TENSION controls each winch group independently and each winch group works in interval during AUTO TENSION mode. You can also easily adjust output torque from 20% to 100% by torque volume knob according to mooring condition.

## INQUIRIES

2F Ichigo Mita Building 5-13-18 Shiba, Minato-Ku, Tokyo, 108-004, Japan  
Tel : +81-3-6435-2966 Fax : +81-3-6435-2015  
E-mail : eigyou\_2@manabezoki.co.jp





# JAPANESE MARINE ECO PRODUCTS

June.2019.Revision

<http://www.jsmea.or.jp/eco-products>



## JSMEA

Japan Ship Machinery and Equipment Association

